

KLINGE



MODEL NMP-282

OPERATION, SERVICE AND PARTS MANUAL



Address: 4075 East Market Street York, PA 17402-5100 USA

Telephone: 717-840-4500 Telefax: 717-840-4501

www.klingecorp.com

MANUFACTURED BY KLINGE CORPORATION

REVISION RECORD

Rev	Description	Date	Approved
A	Removed "SYSTEM 1" from Section 7.3	2018/10/16	BES
B	Updated text and parts information based on thorough review, and addition of "heater" components	2019/09/03	BES
C	Updated Electrical Schematics	2019/10/04	BES
D	Changes to Section 7 to match as-built equipment	2020/09/28	DBG
E	Corrected Section 7.8 Item 3 part #	2021/09/29	BES
F	Corrected temperature range pg 6	2023/07/14	BES

Table of Contents

SECTION ONE - GENERAL DESCRIPTION	6
SECTION TWO - OPERATION	7
2.1 GENERAL INFORMATION	7
2.2 PRE-STARTING CHECK.....	7
2.3 OPERATIONAL CHECK.....	8
2.4 RUNNING UNIT	8
2.5 FUNCTION TEST.....	10
SECTION THREE - ELECTRICAL AND ELECTRONIC FUNCTIONS	12
3.1 GENERAL INFORMATION	12
3.2 ELECTRIC BOX	12
SECTION FOUR - THERMOSTAT INSTRUCTIONS AND SEQUENCE	14
4.1 GENERAL INFORMATION	14
4.2 TEMPERATURE SELECT/DISPLAY PANEL.....	14
4.3 TEMPERATURE PROBES.....	16
4.4 MICROPROCESSOR THERMOSTAT	17
4.5 PHASE SENSING CURRENT LOOPS.....	20
4.6 PRESSURE TRANSMITTER.....	21
4.7 INDEPENDENT TEMPERATURE SENSOR.....	21
4.8 EMERGENCY SWITCH OPERATION (Optional).....	22
4.9 DOOR SWITCH OPERATION	22
SECTION FIVE - MAINTENANCE AND SERVICE INSTRUCTIONS.....	23
5.1 GENERAL	23
5.2 SAFETY	23
5.3 CHECKING REFRIGERANT CHARGE.....	24
5.4 PROCEDURE FOR ADDING REFRIGERANT	24
5.5 NON-CONDENSABLE GASES	25
5.6 OPENING THE SYSTEM	25
5.7 TESTING FOR LEAKS.....	26
5.8 EVACUATING THE SYSTEM.....	26
5.9 SUPERHEAT	26
5.10 PIPING DIAGRAM	28
5-11 ELECTRICAL SCHEMATICS	29
SECTION SIX - TROUBLE SHOOTING	31
6.1 GENERAL INFORMATION	31
6.2 THERMOSTAT LED INDICATIONS	31
6.3 SERVICE COMPONENTS	31
6.4 TROUBLE SHOOTING CHART	32
6.5 ALARM CODE.....	35
6.6 DATA LIST	43
6.7 PTI FORM	43
6.8 LOADING CONFIGURATION.....	43
SECTION SEVEN - SERVICE PARTS	44
7.1 UNIT FRONT VIEW	45
7.2 UNIT REAR VIEW.....	47
7.4 EVAPORATOR VIEW	51
7.5 ELECTRICAL BOX DOORS.....	53
7.6A LEFT-HAND (SYSTEM 1) ELECTRICAL BOX INTERIOR.....	55
7.6B LEFT-HAND (SYSTEM 1) ELECTRICAL BOX EXTERIOR.....	57
7.7A RIGHT-HAND (SYSTEM 2) ELECTRICAL BOX INTERIOR.....	59
7.8 CABLE DIAGRAM.....	63
7.9A SYSTEM 1 CONDENSER PIPING.....	65
7.9B SYSTEM 2 CONDENSER PIPING.....	67
7.9C EVAPORATOR PIPING	69

7.10 CONTAINER PARTS	71
7.11 OPTIONAL DUAL VOLTAGE TRANSFORMER.....	73
7.12 SPARE PARTS KIT	74
SECTION EIGHT - TEMPERATURE RECORDER	77
8.1 INTRODUCTION.....	77
8.2 DATA SECURITY.....	78
8.3 EUROSCAN MANUAL	79

Service Request

Requests for Service should be directed to the Klinge Service Team. The below link should be used to place all requests for service and will afford the quickest response time.

<https://klingecorp.com/request-service/>

This form will help us determine model and age of the equipment, location, basic details about the issue, who to contact and how to best handle the issues with the equipment. A service ticket number will be provided in a response email once the form is received and processed. If the equipment is out of warranty, charges may apply for extensive technical support.

Additionally, our Service Department can be reached via email at technical@klingecorp.com.

Spare Parts Request

Requests for Spare Parts should be directed to our Parts Department via email at spares@klingecorp.com. Please have available at the time of the request the Serial Number of the equipment to ensure that the proper part is provided.

Use of this Manual

The use of this manual is intended for the safe operation of the equipment described. It is therefore reasoned that persons who have the occasion to use this manual have a knowledge of mechanical and electrical systems and components addressed by its' contents. However, efforts have been made to enable persons less familiar with these systems to use this manual.

The equipment may be installed in a number of configurations. Each may have optional items and differing external details provided by third parties. The specific electrical circuit and pipe diagram are posted on the unit as decals.

Most external and internal pipework parts are standard commercially available pipe fittings and not covered here. For external pipe fitting, replace like for like, taking care to replace stainless steel with stainless steel.

Suggestions as to improvement in content and format are welcome and should be addressed to engineering@klingecorp.com. Corrections and improvements will be included on dated revisions – the latest of which will be available upon request.

SECTION ONE - GENERAL DESCRIPTION

The KLINGE NMP-282 Series of refrigeration units are specially designed for the handling of organic goods in ambient temperatures found throughout the world.

These units are designed to maintain temperatures from 2°C (36°F) to 25°C (77°F) automatically, using cooling, heating, and defrost cycles during its operation. Main power is 400/480 volts 3 phase, 50/60 Hz electrical power. Control circuit voltage is reduced to 20/24VAC.

The KLINGE NMP-282 units have two independent systems (left-hand - system 1 and right-hand - system 2). Each system is capable of maintaining temperature. Only one system will operate at any one time, however, both systems need to be switched "ON" to ensure automatic changeover. The first system turned on is considered the Primary system. To ensure runtime is divided across both systems, the primary system will change over to the other system after each defrost cycle. The maximum compressor runtime between defrost cycles is 24 hours.

The electrical section consists of two complete electrical systems for each unit.

The electronic microprocessor thermostats control the temperature of the cargo space. Each system has its own thermostat.

Each system also has its own compressor, evaporator motor and condenser motor. Each system operates with 3.4 kg of refrigerant charge.

Alarm signals occur under the following conditions.

1. Compressor failure shutdown.
2. Cargo temperature is more than 2°C above or below set point and the temperature change rate (up or down) is less than 0.14°C (0.25°F) / hour.
3. Cargo temperature is more than 2°C above or below set point for more than 120 minutes.
4. Cargo temperature outside a user selectable HIGH / LOW setting for the data logger probe (T1 or T3).

As the system operates, the controller takes an hourly "snapshot" of the return air probe temperature. This information is used to determine if the system is functioning properly with respect to temperature pull-down rate and set point temperature.

During the initial temperature pull-down, if the difference between two consecutive hourly snapshots does not show the system is lowering the temperature at the rate of at least 0.17°C (0.3°F) per hour, the system will go into an alarm condition.

Once the system has reached a window within 2°C of the set point, the pull-down rate alarm monitoring is no longer active.

Once the system has reached set point and cycles to maintain the set point, if 2 consecutive hourly snapshots show the return air probe temperature is more than 2°C above or below the set point, the system will go into an alarm condition.

If power is removed from the system, and/or after each defrost cycle, the hourly snapshots will again check for the proper temperature pull-down rate until within the 2°C window to the setpoint.

The unit automatically shifts the "Primary Control" from the system generating the alarm to the other system. The alarm light and horn will remain ON in the system that detected the alarm condition until an operator "resets" the thermostat by switching the ON/OFF switch.

For more details look in the alarm code section.

SECTION TWO - OPERATION

2.1 GENERAL INFORMATION

To understand the sequence of operating the dual refrigeration system, there are several things to remember:

1. System 1, or the left-hand system, is on the left side as you face the unit.
2. System 2, or the right-hand system, is on the right side as you face the unit.
3. The Primary system will be the only complete system running.
 - a. The secondary system evaporator fan will run until the set point is reached.
 - b. The secondary system evaporator fan will restart when the primary system compressor starts again.
 - c. If a failure occurs to the primary system, then the other system will take over.
4. Both systems are equipped with an automatic function test. See section 2.5
5. There are two circuit breakers protecting each electric system. One protects the main line 480 volts 3 phase power; the other protects the 24-volt control circuit.
6. High-pressure switches are located on the compressors and reset automatically.

2.2 PRE-STARTING CHECK

The following inspections should be made before the container is loaded or the unit started.

1. Check unit visually for physical damage.
2. Check of major hold-down bolts etc. visual.
3. Check that control boxes are properly secured in their locked positions.
4. Open control box cover and check that all electric components are secured and that the terminal connections are tight.

NOTE: There should be no power to unit for this check.

5. Check the gasket on control box covers. Be sure the draw latches will hold the covers tightly closed.
6. Check cleanliness of the condenser coils and clean if necessary.
7. Check all refrigerant joints and connections thoroughly for traces of oil, which could be caused by a small refrigerant leak.

2.3 OPERATIONAL CHECK (check each unit separately)

1. Connect main power to unit.
2. Be sure that the CB1 and CB2 circuit breakers are closed in the ON position in both electric boxes.
3. Hold the "Manual Defrost" switch in the **ON** position until the thermostat LEDs flash, and switch the unit **ON/OFF** switch to the **ON** position. The automatic function test will now begin. (See section 2.5)
4. After completion of function test adjust set point to 4-5°C below container temperature. Allow the unit to go through all cycles. At the same time check that all indicator lights on thermostat work.
5. Check amperage of the compressor motor, the condenser motor, and the evaporator motor.
6. Check the rotation of the fans.
7. Adjust set point to 5°C.
8. After temperature reaches 5°C put unit on manual defrost. (Hold defrost switch in **ON** position for 5 seconds).

NOTE: During the defrost cycle, the compressor will continue to run. Condenser motor and evaporator motor will not be running.

9. When defrost cycle is completed let unit run for approximately 15 minutes. Then check refrigerant level in receiver sight glasses.
10. These checks should be conducted on both systems. Turn off the system that has completed the function test before doing the function test on the other system.

2.4 RUNNING UNIT

1. Turn the **ON/OFF** switch on the system that is to be the secondary **ON**. Set thermostat to the desired setting and then turn this system off.
2. Turn system that is to be the primary **ON**. Set thermostat to the desired setting.
3. Turn the other system (secondary) back **ON**.

PHASE SELECTION

When the unit's **ON/OFF** switch is in the **ON** position, power feeds through the current loops. When the thermostat is energized, it scans the phasing of the input power and will allow either phase changing contactor PC1 or PC2 to become energized to ensure the correct rotation of the fans. (See section 4.5 for more info)

COOLING CYCLE

The return air probe is mounted behind the evaporator coil. With this arrangement the probe will be reading the return air. When the cargo space temperature requires maximum cooling, the compressor, condenser, and evaporator fan motors will operate.

This will allow the liquid from the TX valve to cool down the evaporator coil and the air flow from the evaporator fan will circulate the cold air into the container cargo space. The cargo space temperature will continue to pull down until it reaches set point, then the compressor motor and condenser fan motor will stop.

HEATING CYCLE

The return air probe is mounted behind the evaporator coil. With this arrangement the probe will be reading the return air. When the cargo space temperature requires maximum heating, the unit heaters will operate.

The cargo space temperature will continue to rise until it reaches set point.

DEFROST CYCLE

The defrost cycle can only be activated by the system which is the **PRIMARY** system.

The defrost cycle is controlled by a defrost probe mounted at the suction pipe, which will activate the defrost cycle automatically.

When the compressor has been **ON** for at least two minutes, and the temperature difference between the return air temperature probe and the defrost probe reaches a predetermined value, the thermostat will automatically initiate a defrost cycle.

Automatic defrost will also activate under the following circumstances:

1. After 6 continuous hours of compressor run time after start-up.
2. If defrost has not occurred within 9 cumulative compressor hours while in chill mode.
Chill mode is defined as the set point above -7°C .
3. If defrost has not occurred within 18 cumulative compressor hours while in freeze mode.
Freeze mode is defined as the set point below -7°C .
4. After 24 hours of run time since last defrost.

When the unit is on defrost, the hot gas solenoid valves activate so that the hot vapor from the high-pressure side of the compressor goes directly to the evaporator coil.

The hot gas solenoid is deactivated when the temperature of the defrost probe rises to a preset temperature of 18°C (64.4°F), plus 5 minutes, or when the defrost probe reads 38°C (100°F).

If the defrost cycle is not finished within 1 hour, the thermostat will stop the defrost cycle and go to normal operation.

NOTES:

When the primary system defrost probe is "out of range" (open or shorted) the system will automatically shut down and the secondary system will become the operating system.

If the defrost probe is "out of range" an alarm code will be shown in the display.

If the system calls for defrost within 30 minutes after a defrost cycle has ended, an alarm code will be shown in the display, and the unit will not go into another defrost cycle.

The defrost cycle can also be manually activated. On the primary system, hold the manual defrost switch **ON** for a minimum of 5 seconds.

UNLOAD SYSTEM

The compressor unload system can be active in different situations.

1. In Chill cool mode, to make a uniform supply air temperature to the container.

2. In Chill heat mode, to make a uniform supply air temperature to the container.
3. To reduce the compressor current use.
4. To lower high pressure at the system, on start-up and in high ambient temperature.

2.5 FUNCTION TEST

The thermostat is provided with an automatic function test, which energizes the compressor motor, condenser motor, evaporator motor, alarm lamp, alarm horn and tests the probes.

NOTE: Steps of the Function Test are listed on the right-side label of the thermostat and are also on the electrical schematic.

To start the Function Test program:

1. Press the MANUAL DEFROST/FUNCTION TEST button.
2. Press the **ON/OFF** button. Display will show the software version and then the current set point.
3. After approximately 10 seconds (all LEDs will flash) release the MANUAL DEFROST/FUNCTION TEST button and the function test will run.

The test **must** only be run on 1 system at a time.

Step 1:

Phase sensing test.

If the power is sensed coming into the unit as L1-L2-L3 then the controller will test PS2 for proper functionality.

If the power is sensed coming into the unit L1-L3-L2 then functionality was already tested as part of the start-up process.

LED 3 will flash

The controller will deactivate PS1 and will activate PS2.

After one second the controller will activate the evaporator fan relay.

After four seconds the controller will test that there is a minimum of 0.3A at each phase.

If PS1 and PS2 function properly the function test will continue to Step 2, and LED 3 will be turned ON.

The display will show the actual amps used.

Step 2:

Evaporator fan on.

LED 4 will flash

Controller checks if amps are within limits.

(If amps are lower than 0.3A or higher than 1.1A, then test failed)

The controller also checks the highest and lowest amps measured, if the highest amps measured is twice the lowest, there will be an alarm.

The display will show the actual amps used by the evaporator fan.

Step 3:

Condenser fan on, Evaporator fan on

LED 5 will flash

Controller checks if amps are within limits.

(If amps are lower than 1.0A or higher than 3.0A, then test failed)

The controller also checks the highest and lowest amps measured, if the highest amps measured is twice the lowest, there will be an alarm.

The display will show the actual amps used by the condenser fan and evaporator fan.

Step 4:

Compressor on

LED 6 will flash

Controller checks if amps are within limits.

(If amps are lower than 5.0A or higher than 16.0A, then test failed)

The controller also checks the highest and lowest amps measured, if the highest amps measured is twice the lowest, there will be an alarm.

The display will show the actual amps used by the compressor.

Step 5:

Compressor is on and unload is on.

LED 7 will flash

The controller also checks that the ampere use in step 5 is less than the ampere use in step 4, if not then there will be an alarm.

The display will show the actual amps used by the compressor.

Step 6:

Compressor is on and hot gas is on.

LED 8 will flash

The display will show the actual amps used by the compressor.

Step 7:

Alarm relay is de-energized.

LED 9 will flash

The alarm LED will flash, and the alarm horn will sound.

If the external alarm monitor is connected, it will trigger external alarm monitor.

If the Manual Defrost button is activated, then the horn will stop sounding, and the controller will jump to the next test step.

Step 8:

Temperature sensor test

LED 10 will flash

Display will toggle between defrost probe temperature, supply probe temperature, and return air probe temperature.

If the difference between the probes is less than 5°C the test passes.

If the difference between the three probes is greater than 5°C the evaporator fan will turn on for up to 8 minutes to bring the sensed temperatures to within 5°C.

If after 8 minutes the temperatures are still not inside the 5°C range, the temperature sensor test will fail.

NOTE: If all steps of the function test are passed, all LED's will be on for 10 seconds and after that the controller will return to normal operation.

If there has been any alarm, the LED for that step will flash for ½ hour and the alarm code is shown in the display and will remain in the display for ½ hour. After this ½ hour delay the controller will return to normal operation.

SECTION THREE - ELECTRICAL AND ELECTRONIC FUNCTIONS

3.1 GENERAL INFORMATION

Both electric boxes are identical with two minor exceptions.

- A. The left-hand box includes the battery charging system.
- B. The right-hand box includes the data logging system.

When high voltage is fed to the unit through the current phase loops, and the circuit breaker CB1 is in the **ON** position, power will pass along L1, L2 and L3 to the compressor, the phase changing contactors and transformers.

Note: Beware of high voltage (400-480 volt) in various parts of the unit, especially when CB1 is in the ON position. It is recommended that a thorough study of the wiring diagram be made to determine where high voltage may be encountered when electric power is fed to the unit.

3.2 ELECTRIC BOX

CIRCUIT BREAKERS

- A. Circuit Breaker (CB1).
The 25-amp circuit breaker has three poles. It is reset manually and protects the entire unit against overload. It may be used as a switch.
- B. Circuit Breaker (CB 2).
An 8-amp circuit breaker (CB2) protects the 24-volt control circuit, and the 12-volt thermostat circuit in case of possible overload.
- C. Circuit Breaker (CB3).
A 4-amp circuit breaker (CB3) protects the 12 VDC alarm circuit.

CONTACTORS

- A. Compressor Motor Contactor (C)
This is a 3 pole, 480-volt, contactor with a 24-volt operating coil. It operates the compressor motor and is energized by the thermostat.
- B. Condenser fan contactor (CF)
This is a 3 pole, 480-volt, contactor with a 24-volt operating coil. It operates the condenser motor and is energized by the thermostat.
- C. Phase Changing Contactors (PC1 & PC2)
These are 3 pole, 480-volt contactors with a 24-volt operating coil. The rotation of the evaporator and condenser motors is controlled by these contactors and they are energized by the MPC4 thermostat (terminals 1 or 2 on the MPC4 thermostat). They have a mechanical interlock to prevent accidental energizing of both at the same time.
- D. System Change
The first system turned **ON** is primary. The MPC4 thermostat CAN bus detects the system that is turned on first and makes that system to be primary. If a problem occurs with the primary system, then the MPC4 thermostat makes the other system primary.
- E. Heater Contactor (H)

This is a 3 pole, 480 volt, contactor with a 24-volt operating coil. It operates the unit heaters and is energized by the thermostat.

- F. Temperature Relay (TR) (Optional)
When the product temperature is out of range the temperature relay will be energized by the recorder.

MOTOR PROTECTION

The evaporator fan motors have an internal thermal switch to protect the motors from single phasing, overheating and overloads. The internal switch will automatically reset after cooling.

Additional protection for the compressor and condenser fan motor circuits is performed by overloads. The overloads are set for automatic reset. See data list (Section 6.6) for amperage trip setting values.

Normally closed. (OL1 & OL2).

Motor protection switches are automatically reset.

Compressor, condenser fan motor and evaporator fan motors stop immediately if failure occurs.

Immediately the unit will automatically switch to the other system, if the other system is not in an alarm state.

TRANSFORMERS

Control circuit transformers (T1) are located in the left and right-hand control boxes.

The primary windings are tied onto the 480 VAC line after the 25A circuit breaker. The secondary windings supply the 24 VAC for the control circuit, and the 12 VAC for thermostat logic.

BATTERY CHARGING SYSTEM

This is located in the left-hand control box. In case of a malfunction in the unit, it is necessary to keep the battery optimally charged. The battery charging system works when the unit is connected to the power supply. The battery charger has an LED to indicate power on.

When the genset is active an engine relay will disconnect this battery charger.

HIGH PRESSURE SWITCH (HP)

Normally closed when pressure is in range.

Switch is automatically reset.

Compressor stops immediately if failure occurs.

Failure signal to alarm lamp and horn will have 12 minutes delay.

Immediately the unit will automatically switch to the other system, if the other system is not in an alarm state.

SECTION FOUR - THERMOSTAT INSTRUCTIONS AND SEQUENCE

4.1 GENERAL INFORMATION

Several components are used to control the system temperature:

- A. Temperature select/display panel
A display panel is mounted in both control boxes.
- B. Temperature probes
Each system uses 4 probes to monitor temperatures:
 - a. Supply air
 - b. Return air
 - c. Defrost probe, mounted on the suction pipe in the evaporator section
 - d. Compressor discharge probe
- C. Microprocessor thermostat
A thermostat is mounted in both control boxes.
- D. Phase sensing current loops
- E. Pressure transmitter

4.2 TEMPERATURE SELECT/DISPLAY PANEL

4.2.1 General Description

The temperature select/display panel consists of three touch pad switches for operator input and a three-position alpha-numeric display as shown in Figure 1.

Display panel shows:

- A. Return air temperature – during normal operation
 - B. Set point temperature – by momentarily pushing the \wedge (up) or \vee (down) touch pad switch
 - C. Defrost probe temperature – by momentarily toggling the **MANUAL DEFROST** switch
 - D. Alarm code – when system has experienced an alarm fault
- For additional alarm code information see Section 6.5.

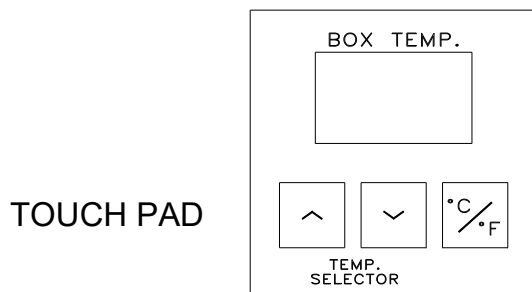

Figure 1

The temperature setting (set point) is stored in a nonvolatile memory and will always be intact even in case of power failure.

In order to prevent false entry or accidental changes of values, both selector buttons (\wedge and \vee) must be depressed simultaneously for a new setting to be entered into the memory.

4.2.2 Display Panel Operation

Creating a Temperature Set Point:

1. Pressing the **^** (up) or **v** (down) touch pad switch causes the display to show the current set point.
2. After the current set point is displayed, each pressing of one of these touch pad switches will increment or decrement the display by one whole degree.
3. Holding a touch pad switch pressed will cause the display to change one degree each half second.
4. Simultaneously pressing both touch pad switches causes the current set point to be saved (display will blink once when set point is saved). This set point will be used until another set point is chosen, even if power is removed from the thermostat.
5. The display automatically returns to normal display mode approximately five seconds after the touch pad switch has been released.

NOTE: The equipment can be protected from accidental or unauthorized changing of the set point by using a PIN Code. If a PIN Code is in use, contact the equipment owner for the code, then use the below step by step process for entering the PIN Code to allow you to change the Set Point.

1. When the unit is in operation the current Set Point will be displayed by pressing either the UP or DOWN button. This will display the current Set Point.
2. When you press either the UP or DOWN button again the word "Pin" will be displayed.
3. When the word "Pin" is displayed you then press the C/F Key one time.
4. The display will now show 0 as the first digit, at this time you will need to enter the first digit of the PIN Code.
5. Once the first digit has been entered press the C/F key to move to the second digit.
6. The display will now show 0 as the second digit, at this time you will need to enter the second digit of the PIN Code.
7. Once the second digit has been entered press the C/F key to move to the third digit.
8. The display will now show 0 as the third digit, at this time you will need to enter the third digit of the PIN Code.
9. Once the third digit has been entered press the C/F key to confirm the PIN CODE that you have entered.
10. If the PIN Code that has been entered is not correct the Temperature Display will read "Pin".
11. If the code that has been entered is correct the Temperature Display will show the Return Air Temperature. At this point the Set Point can be set through the normal process. It should be noted that the Set Point will remain unlocked for 3 minutes after the PIN Code has been entered. After 3 minutes the PIN Code will need to be entered again.

Changing Temperature Mode:

1. The thermostat can operate in either degrees Centigrade (°C), or Fahrenheit (°F).
2. Pressing the **C/F** key causes the display to indicate the current mode. This is indicated by a **C** or **F** in the right character of the display. A decimal point is displayed in the right most character when in **F** mode.

3. Each pressing of the **C/F** key causes the mode to change.
4. After selecting °C or °F, pressing either the **▲** (up) or **▼** (down) touch pad switch will cause the currently selected mode to be saved and the display will immediately return to normal mode.
5. The display automatically returns to normal display mode approximately five seconds after the last touch pad switch press.

4.3 TEMPERATURE PROBES

The temperature sensing devices are probes consisting of a thermistor, sealed in an epoxy filled stainless steel tube. These probes are strategically placed on the unit to monitor temperature parameters essential to effective system performance. The probes transmit the desired temperature signal to the thermostat via a two-conductor shielded cable.

This unit requires 8 temperature sensors, 4 for the Left-Hand System and 4 for the Right-Hand System.

Each system has its' own independent return air probe, supply air probe, compressor discharge probe and defrost probe.

- A. The compressor discharge probes connect to the thermostats at terminals 37 and 33(common).
- B. The supply air probes connect to the thermostats at terminals 36 and 33(common).
- C. The return air probes connect to the thermostats at terminals 35 and 33(common).
- D. The defrost probes connect to the thermostats at terminals 34 and 33(common).

Accuracy of the probes is:

TEMPERATURE RANGE	TOLERANCE
-40°C to -20°C	+/-0.75°C
-20°C to -10°C	+/-0.4°C
-10°C to 70°C	+/-0.2°C

Checking of temperature should be done with an instrument with equal or better accuracy. The thermostat cannot be calibrated.

An opened or shorted probe will be indicated with an alarm, see alarm codes in Section 6.5 for more information.

If a probe or cable becomes defective, check the probe assembly and the thermostat connection first to confirm a shorted or open circuit. Then disconnect the probe to determine whether the probe or cable is defective.

WARNING

Stop the unit and disconnect the main power to the unit when disconnecting and measuring resistance of a probe.

It is important that the sensor is properly mounted. Use an ohmmeter to check probes. A short circuit indicates 0 ohms resistance. An open circuit indicates infinite ohms resistance. Good readings should agree with the chart below:

PROBE RESISTANCE CHART		
Probe at Ambient Temperature		K-Ohms (Approx.)
°C	°F	
+ 25	+77	10.0
+ 20	+68	12.5
+ 15	+59	15.7
+ 10	+50	19.9
+ 5	+41	25.4
0	+32	32.6
- 5	+23	42.3
- 10	+14	55.3
- 15	+5	72.9
- 20	- 4	97.0
- 25	-13	130.2

4.4 MICROPROCESSOR THERMOSTAT

This device contains all circuits necessary to select the required functions to maintain an accurate temperature. The selection is based on signals received from the probes and touch pad/display panel.

NOTE: Being electronic, the thermostat does not react immediately to setting changes.

Several time delays are incorporated in the microprocessor thermostat logic and are not adjustable.

Two kinds of indicator LEDs are provided for determining the correct function and as an aid to servicing the unit:

- A. LEDs mounted on the front of the thermostat.
These LEDs will indicate which function is being called for by the thermostat logic.
These LEDs are visible from the front of the unit.
- B. LEDs mounted next to each thermostat relay to
These LEDs show if the associated relay is energized.
These are small red LEDs and can only be seen from the side of the device.

FRONT EDGE LEDs

10 LEDs are visible at the front of the thermostat and indicate the unit status as follows:

1. **ON**
Green LED indicates the **ON/OFF** switch is in **ON** position.
2. **ALARM ON**
Red LED indicates when any alarm occurs.
3. **PHASE OK**
Clear LED indicates that phase direction is detected.

4. **PRIMARY SYSTEM**
Clear LED indicates that this is the primary (controlling) system.
5. **COMPRESSOR FAIL**
Clear LED indicates failure on high-pressure switch or motor protection.
6. **TEMPERATURE FAILURE**
Clear LED indicates temperature out of range or pull-down rate too slow.
7. **DEFROST**
Clear LED indicates defrost mode.
8. **COMPRESSOR**
Clear LED indicates the thermostat logic is calling for cooling.
9. **HEAT**
Clear LED indicates the thermostat logic is calling for heat.
10. **UNLOAD**
Clear LED indicates that thermostat logic is calling for compressor unloading.

THERMOSTAT RELAYS

A small red LED is placed adjacent to each of the 8 thermostat relays. An illuminated LED indicates its associated relay is energized.

1. **PHASE RELAY (AR1)**
De-energize when phase is L1-L2-L3.
Energize when phase is L3-L2-L1.
2. **ALARM HORN RELAY and ALARM LAMP RELAY (AR2)**
T6 is common.
The relay is energized during normal operation (continuity from T5 to T6), and will de-energize, if an alarm occurs (continuity from T6 to T4).
There will be momentary continuity from T6 to T4 when unit is stopped.
3. **HEATER RELAY (AR3)**
The relay will be energized when the thermostat is calling for heating.
4. **UNLOAD RELAY (AR4)**
The relay will be energized when the thermostat logic is calling for unload.
5. **CONDENSER FAN RELAY (AR5)**
Normally open
The relay will be energized when the thermostat logic is calling for unload.
6. **COMPRESSOR RELAY (AR6)**
Normally open
The relay will be energized when the thermostat logic is calling for cooling, heat and defrost.
The relay energizes the compressor motor.
7. **EVAPORATOR FAN RELAY (AR7)**

Normally open.

Primary system: This relay will be energized at all times except during defrost.

Secondary system: This relay will be energized when the primary system is in cool or heat mode.

The relay gives a signal to the AR1. PC1 or PC2 will then energize the evaporator fan motor.

8. DEFROST RELAY (AR8)

Normally open

The relay will be energized when the thermostat logic calls for defrost or heat.

This relay energizes the solenoid of the hot gas valves.

4.4.1 THERMOSTAT SEQUENCE

When starting the unit with the temperature selector set at least 1.2°C below the container temperature the unit will start up with a test of the main components. This test will also be performed after a defrost cycle and at system change.

After the test is performed the unit returns to normal operation.

START-UP TEST

The test is automatically performed by the controller when the unit **ON/OFF** switch is set to **ON**.

Phase selection

At power **ON**, the evaporator fan is started to detect the phase direction, if there is no power use at the evaporator fan, then the condenser fan is started.

When phase direction is detected, after approximately 5 seconds, LED3 is lit and the evaporator and condenser fans are stopped.

If the phase direction is wrong, then relay 1 on the controller will be activated. This will turn off PS1 and turn on PS2.

If phase direction can't be detected, LED2 and LED3 will flash. After 5 minutes the controller will try to find the phase direction again. This will continue until the phase direction is detected.

Approximately 10 seconds after the controller has found the phase direction, the test will start.

Step 1: Evaporator fan on

Controller checks if amps are within limits.

(If amps are lower than 0.3A or higher than 2.0A, then test failed)

The controller also checks the highest and lowest amps measured, if the highest amps measured is twice the lowest, there will be an alarm.

Step 2: Evaporator fan on and condenser fan on

Controller checks if amps are within limits.

(If amps are lower than 0.5A or higher than 3.0A, then test failed)

The controller also checks the highest and lowest amps measured, if the highest amps measured is twice the lowest, there will be an alarm.

Step 3: Compressor on

Controller checks if amps are within limits.

(If amps are lower than 5A or higher than 13A, then test failed)

The controller also checks the highest and lowest amps measured, if the highest amps measured is

twice the lowest, there will be an alarm.

NOTE: If there has been any alarm, the alarm code is shown on the display panel and will remain displayed until it is reset using the touch pad C/F switch. After the start-up test is complete the controller will return to normal operation.

4.4.2 COOLING and HEATING SEQUENCE

CHILL MODE

Falling temperature at cooling.

Evaporator fan will run continually.

Compressor will run until the return air is at set point.

Condenser fan will run until the return air is at set point.

When the return air is 2°C from set point, the unload valve is active.

Rising temperature at cooling.

Evaporator fan will run continually.

Compressor will start when the return air is 1°C above set point.

Condenser fan will start when the return air is 1°C above set point.

When the return air is 1°C above set point, the unload valve is on until the return air is 4.0°C above the set point.

HEATING MODE

Rising temperature at heating.

Evaporator fan will run continually.

Unit heaters will run until the return air is at set point.

4.5 PHASE SENSING CURRENT LOOPS

The current sensing devices are 3 sensors consisting of a solenoid, sealed in an epoxy shell.

These sensors are placed on a common board and are connected to the MPC4 thermostat with 4 wires.

The 3 main power phase lines are then taken through the solenoids, to read the phase detection, the hertz and the current at the main power line.

With these inputs the MPC4 thermostat can detect the phase direction and activate PC1 or PC2 for correct rotation of the fans.

If phase detection fails, the MPC4 thermostat will wait until the correct phase direction is found.

If the phase system is not able to detect the correct direction, the system can be disabled at parameter P32 in the Config menu.

If parameter P32 value is 0, then PC1 will always be active. (Important check rotation of fans.)

If a sensor or cable becomes defective, check the sensor assembly and the thermostat connection first to confirm a shorted or open circuit. Then check the sensor to determine whether the sensor or cable is defective.

WARNING

Stop the unit and disconnect the main power to the unit.

It is important that the sensor is properly mounted. Use an ohmmeter to check each solenoid. A short circuit indicates 0 ohms resistance. An open circuit indicates infinite ohms resistance. Good readings should agree with the data below:

Readings are at +20°C.

Dismount the MPC4 thermostat from the control box.

At terminal 33 to 21 there must be from 40 to 45 ohms.

At terminal 33 to 22 there must be from 40 to 45 ohms.

At terminal 33 to 23 there must be from 40 to 45 ohms.

4.6 PRESSURE TRANSMITTER

The pressure transmitter devices are a transmitter that is placed on the discharge line from the compressor.

The transmitter is connected to the MPC4 thermostat with 2 wires.

The transmitter reads the pressure in the system, and from this the MPC4 thermostat can control the condenser fan, the unload valve and show the pressure in the display.

The transmitter type is a 4 to 20 mA output.

4.7 INDEPENDENT TEMPERATURE SENSOR



This system is equipped with an adjustable, external, independent temperature sensor. The body (blue component in above photo) of the temperature sensor is mounted in the condenser section, with a probe placed in the evaporator section, attached via capillary.

If the temperature sensor is out of the set range, an alarm sounds. This temperature sensor is not tied into the Klinge control system. Therefore, an alarm from this component would require a technician's attention to de-activate the alarm and determine if the refrigeration requires troubleshooting or maintenance for proper unit operation.

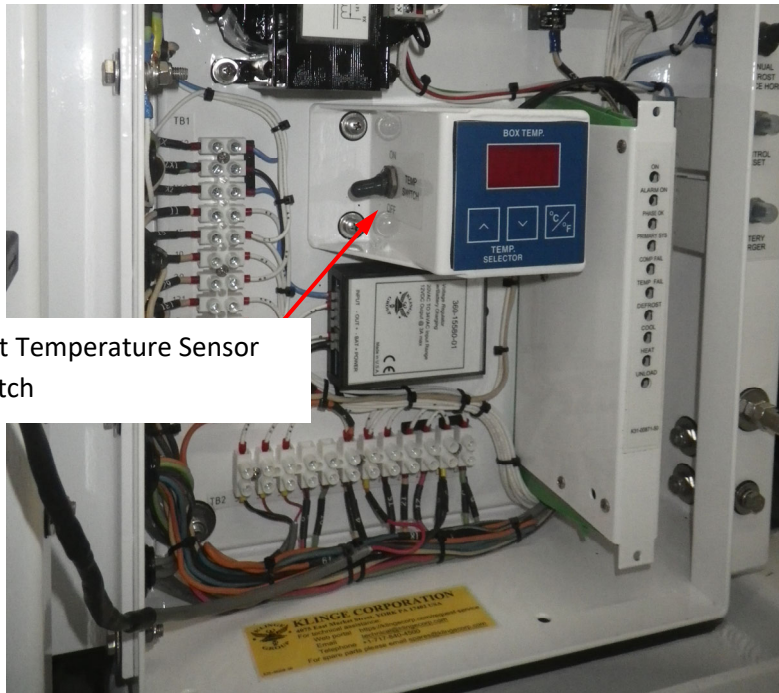

Independent Temperature Sensor
ON/OFF switch

To make the Independent Temperature Sensor inactive, an ON/OFF switch is mounted to the Temperature Select/Display Panel bracket of System 1.

4.8 EMERGENCY SWITCH OPERATION (Optional)

In the event of an emergency, press the red mushroom button inside the container. This will turn off the unit, if desired, and produce a unit alarm.

4.9 DOOR SWITCH OPERATION

This unit is installed with a door switch that will turn off all refrigeration operation when the container door is open. When the container door is open DOO will be shown on the display.

If the container door is open for an extended amount of time, the unit will produce an alarm and A44 will be shown on the display.

SECTION FIVE - MAINTENANCE AND SERVICE INSTRUCTIONS

5.1 GENERAL

This section provides procedures for establishing preventative maintenance and systematic servicing schedules, which are the keys to successful operation.

All service and maintenance procedures should be performed in accordance with Section 608 of the Clean Air Act (CAA), prohibiting the venting of refrigerants into the atmosphere and providing for the use of refrigerant recycling and recovering equipment to be used whenever a system is opened.

5.2 SAFETY

- A. Safety glasses should be worn at all times when operating or servicing the refrigeration unit.
- B. When any work is to be done on the components of the refrigeration system, be sure that the unit cannot be started automatically or accidentally. If valves are closed and/or circuits interrupted during service procedures, the control switches should be suitably tagged with such notations.
- C. Beware of high voltage in various parts of the unit, especially when main CB1 is on. It is recommended that a thorough study of the wiring schematic be made to determine where high voltage will be encountered before electric power is applied to the unit.
- D. Special attention should be given to the Main Power Plug and Receptacle when disconnecting from each other. When disconnecting these two items ensure that the power circuit breaker has been turned to the off position. Do not pull at the cable but rather with a firm grip on the housing, grab the plug and receptacle and pull apart. If the cable is used rather than the housing the risk exists that the wires within the housing could become dislodged and lead to a future electrical hazard.
- E. Do not exert excessive pressure when tightening flare nuts, as it may result in a rupture of the flare or stripped threads.
- F. Always wear approved goggles or eye shields when working with refrigerant to prevent eye injury if refrigerant is accidentally discharged into the face of the service engineer.
- G. Never, under any circumstances, apply heat to a refrigerant cylinder by using a naked flame. Should it be considered necessary to apply heat to a cylinder to create a refrigerant flow when recharging a system, place the cylinder in a container of hot or warm water to a point about 3/4 of the height of the cylinder.

Even this method requires that a pressure gauge is in use in the charging line to indicate the pressure in the cylinder at all times.

Also, never close the shut-off valve in the cylinder while the cylinder is being heated. The use of a manifold gauge set will permit compliance with CAA regulations by having a gauge in the line and a shut-off valve on the manifold to stop the flow of refrigerant into the system and allow the gauge to read cylinder pressure.

- H. Always replace refrigerant cylinder valve and connection caps after using the cylinder, and do not permit a cylinder to be dropped or hit severely by another object.

- I. Container related safety items:
 - a. Due to the height at which the refrigeration unit is placed in the container, always use safe and secure means to service the unit and to allow a platform for tools and a refrigerant cylinder.
 - b. The internal space of the container should only be accessed by trained staff. It is suggested that specific company-based SOP's be established to monitor and govern this.
 - c. The roof of the container should only be accessed by trained staff. It is suggested that specific company-based SOP's be established to monitor and govern this. Also, it is highly recommended that proper fall protection is utilized.
 - d. Proper securing of internal cargo should be done to company established SOP's based on the type of cargo being stored and transported.

CAUTION:

A gauge manifold should always be used when charging unit with refrigerant.

Refrigerant R-134a is heavier than air. Therefore, it settles in the lowest places and will expel air (oxygen) from a small confined space, resulting in dizziness or suffocation to an occupant.

5.3 CHECKING REFRIGERANT CHARGE

The receiver sight glasses are equipped with a ball, which floats when the liquid level is in the sight glass, or above.

It should be noted and remembered that the only requirement of liquid level is that a seal be maintained at the outlet of the receiver. At low ambient temperatures, approximately 50°F and below, the liquid refrigerant may not accumulate in the receiver to a point where a liquid level will show on the sight glass. Many times, the liquid will accumulate in the condenser. Therefore, caution should be taken before adding refrigerant. Air in the receiver may also prevent the level from coming up into the sight glass. This can be rectified by purging the air from the system.

If the ball is not floating, it is recommended that the suction and discharge pressure be checked before determining that the charge is low. It is just as possible to do harm to the system by overcharging as it is to run the system under charged.

It is important to have the correct amount of refrigerant in the system. The charge required is 4.3 kg at each system. If there is too little, the expansion valve will pass vapor and reduce the capacity of the evaporator. Too much refrigerant will result in higher head pressures and reduced capacity.

NOTE: Before adding refrigerant, always determine the reason for the low charge and remedy the cause. Leak test thoroughly with an electronic leak detector and also check for traces of oil.

5.4 PROCEDURE FOR ADDING REFRIGERANT

To add small quantities of refrigerant to the system, it is preferable to add gas to the low or suction side of the system. This will allow the system to operate with little or no disturbance of the refrigeration cycle while the refrigerant is being added.

Care should be taken to ensure that only gas is extracted from the refrigerant cylinder when charging into the low side.

1. Remove the compressor suction service valve cap and back seat the valve. This closes the charging port. Loosely attach the suction gauge line of a manifold set. Connect the center charging line to a refrigerant cylinder and tighten the connection.
2. Crack open the refrigerant cylinder valve and the manifold suction gauge valve and purge the air from the line. Then tighten the connection at the compressor suction service valve.
3. With the system still operating and the suction pressure being 30 psig or below, and the cylinder pressure at 170 psig (dependent upon ambient temperature), open the refrigerant cylinder valve and the manifold suction gauge valve completely. Open the compressor suction service valve 1 to 2 turns.
4. Allow refrigerant into the system and observe the receiver sight glass.
5. If the pressure in the refrigerant cylinder equalizes the suction pressure of the system, charging will cease until the cylinder pressure is raised by heating it. To do this, a container of hot water or an electric blanket (made for this purpose) can safely be used.
6. If the pressures equalize and no heating is available, partially front seat the compressor suction service valve and allow the system to pump down to a pressure slightly below the one of the cylinder pressure. This will create a pressure difference between the system and the cylinder, allowing refrigerant to flow again. However, remember to close the cylinder or manifold valve before opening the compressor service valve, or R-134a will be forced back into the cylinder. Also, the system should be allowed to cycle for at least 5 minutes after each shot of refrigerant to allow it to settle so that an accurate reading can be taken at the receiver sight glass.
7. When it is determined that the system has an adequate refrigerant charge, close the refrigerant cylinder valve (if not already closed), and the manifold suction gauge valve, and back seat the suction service valve, in that order. Remove the manifold lines and replace caps securely.

5.5 NON-CONDENSABLE GASES

Air and non-condensable gases in any system gather in the receiver above the liquid. This will result in above normal discharge pressures. These gases can be removed during operation by purging through the receiver valve. To purge, use recycle equipment and open valve a small amount. Note any significant difference from the initial pressure when the valve is again closed. Repeat the operation until the discharge pressure is normal.

5.6 OPENING THE SYSTEM

Whenever it is necessary to open a charged or functioning system to make repairs or replacements, it is necessary to comply with CAA by using recovery and recycle equipment.

The use of "**EASY FLOW**" silver solder and flux, or equivalent, is recommended in the refrigerant system piping. Do not use soft solder.

Prior to disturbing any connections, the type of solder originally used should first be verified then continue. By taking this precaution, the contamination of the joint will be avoided.

5.7 TESTING FOR LEAKS

The preferred method for finding leaks is by use of an electronic leak detector. There are several different makes available, and they all use the same method of detecting a leak through an exploring tube which will detect from large to extremely small leaks depending on the setting used on the detector.

Leak testing with soapsuds will reveal only the large leaks and is therefore ineffective in determining the tightness of a system.

5.8 EVACUATING THE SYSTEM

CAUTION

Do not use the compressor as a vacuum pump or as an air compressor. It is not designed to handle air and will not pull down to as low a vacuum as a pump designed for that purpose. Similarly, if used to compress air, serious overheating and consequent damage may be the result.

Connect a pump capable of drawing a vacuum of 0.15 mm Hg or greater to that part of the system which has been opened. Continue until all air and moisture has been removed.

The final evacuation may be accelerated, however, by manifolding the connections to the vacuum pump and evacuating simultaneously the high and the low sides of the system; the vacuum should be broken by introducing refrigerant.

Too much emphasis cannot be placed on the importance of keeping the system free of moisture. Slight amounts of water in the system will inevitably lead to trouble in the following forms:

- A. Corrosion of steel parts.
- B. Copper plating of the shaft and bearing.
- C. Sludging or gumming of the oil.
- D. Plugging of the strainers and dryers.
- E. Freezing and plugging of expansion valve

Whenever it is necessary to open the system for any reason, always take precautions to prevent the entrance of air into the system, as air always contains some water vapor. Isolate as much of the system as possible from the portion to be opened by closing suitable valves.

5.9 SUPERHEAT

Adjustment of TX Valve

The expansion valve is set and tested at the factory before shipping. Klinge DOES NOT recommend adjusting the super heat setting of the TX valve. However, in very rare situations when the TXV is faulty, the super heat can be adjusted.

The expansion valve adjustment is capped for protection. Remove the protective cap. To reduce the superheat, turn the adjustment stem counterclockwise or to the left. To increase, turn the adjustment stem clockwise or to the right.

Only make one full turn at a time, it may take approximately 30 minutes after each adjustment before a new balance can be acquired.

To properly check the super heat, set the thermostat to -10°F. After waiting 5 minutes observe the suction line, it should be frosted back to the suction service valve without frost on the valve. The bottom of the compressor should be warm to the touch.

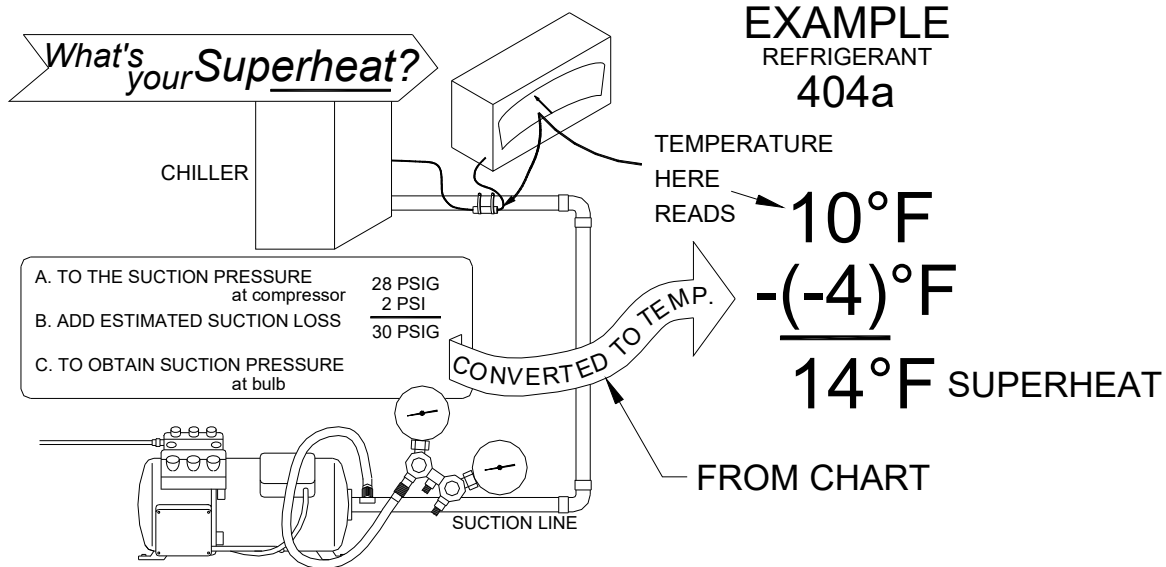

Measuring the Superheat

1. Measure the temperature of the suction line at the point the TXV bulb is clamped.
2. Obtain the suction pressure that exists in the suction line at the bulb as follows:
 - a. Read the gauge at the suction valve of the compressor. To the pressure add the estimated pressure drop through the suction line between bulb location and compressor suction valve.
 - b. The sum of the gauge reading, and the estimated pressure drop will equal the approximate suction line pressure at the bulb.
3. Convert the pressure obtained in 2 to saturated evaporator by using the temperature /pressure chart provided in this manual.
4. Subtract the two temperatures obtained in 1 and 3 – the difference is the superheat.

5.10 PIPING DIAGRAM

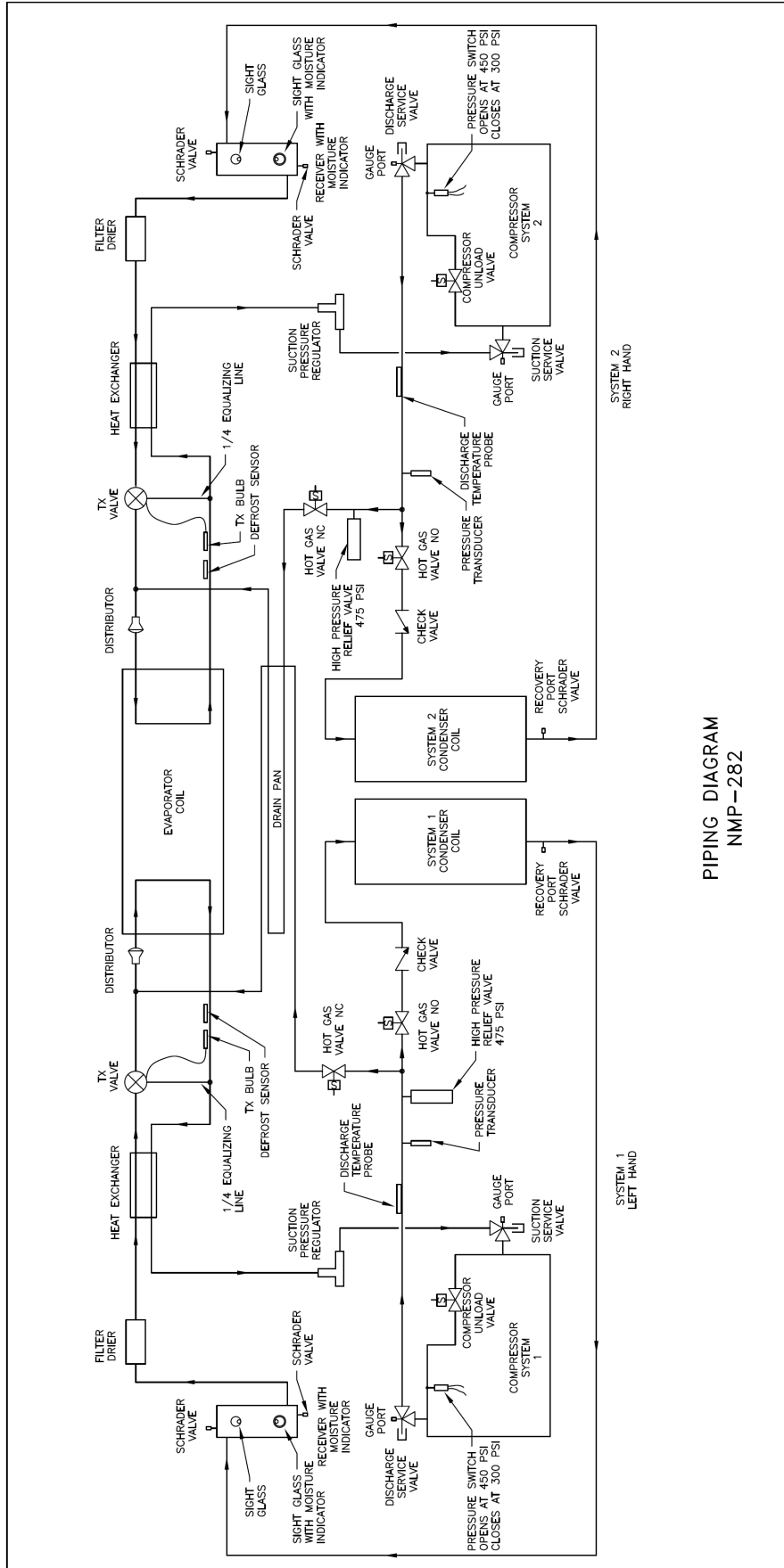

PIPING DIAGRAM
NMP-282

5-11 ELECTRICAL SCHEMATICS

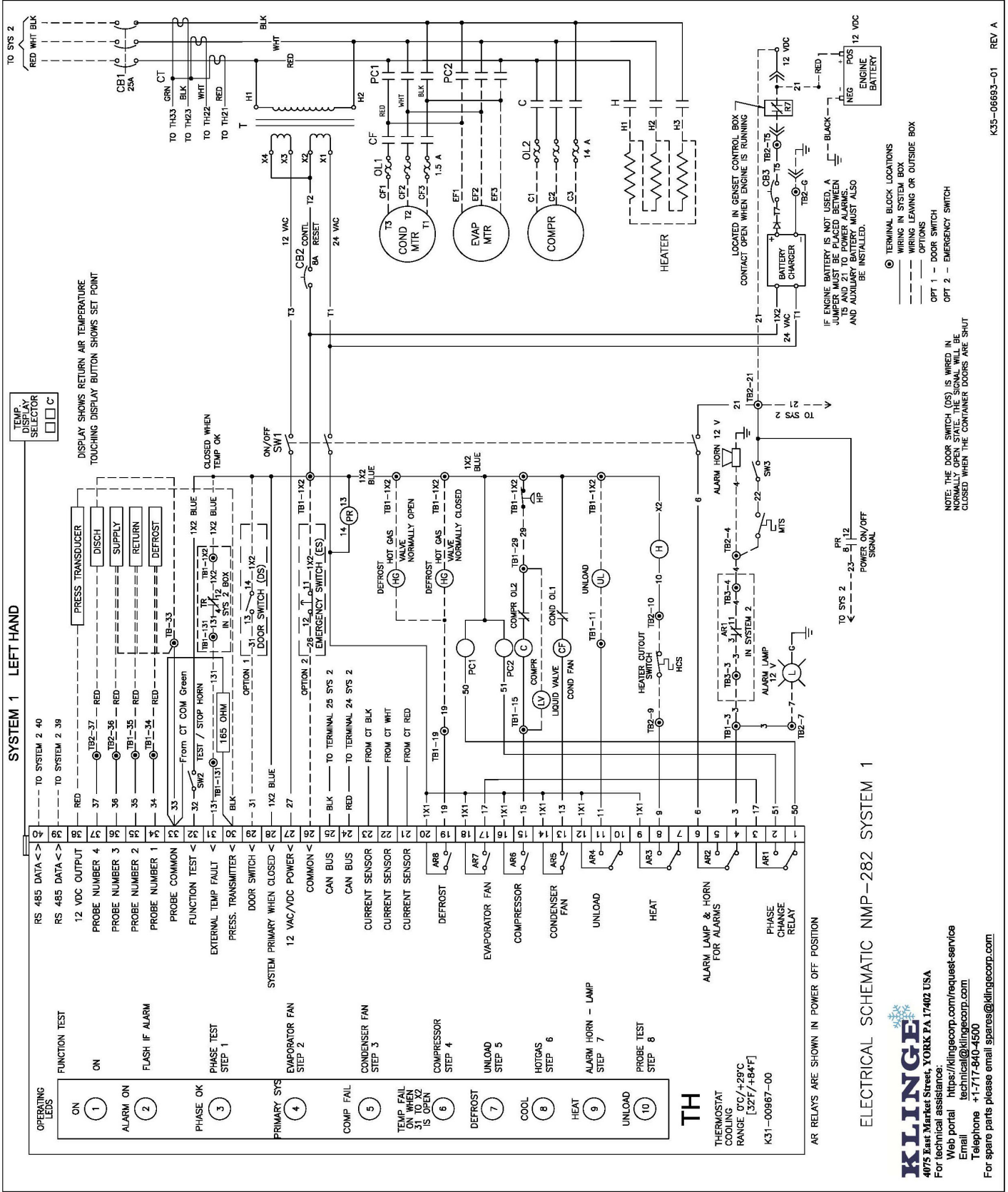

SYSTEM 2 RIGHT HAND

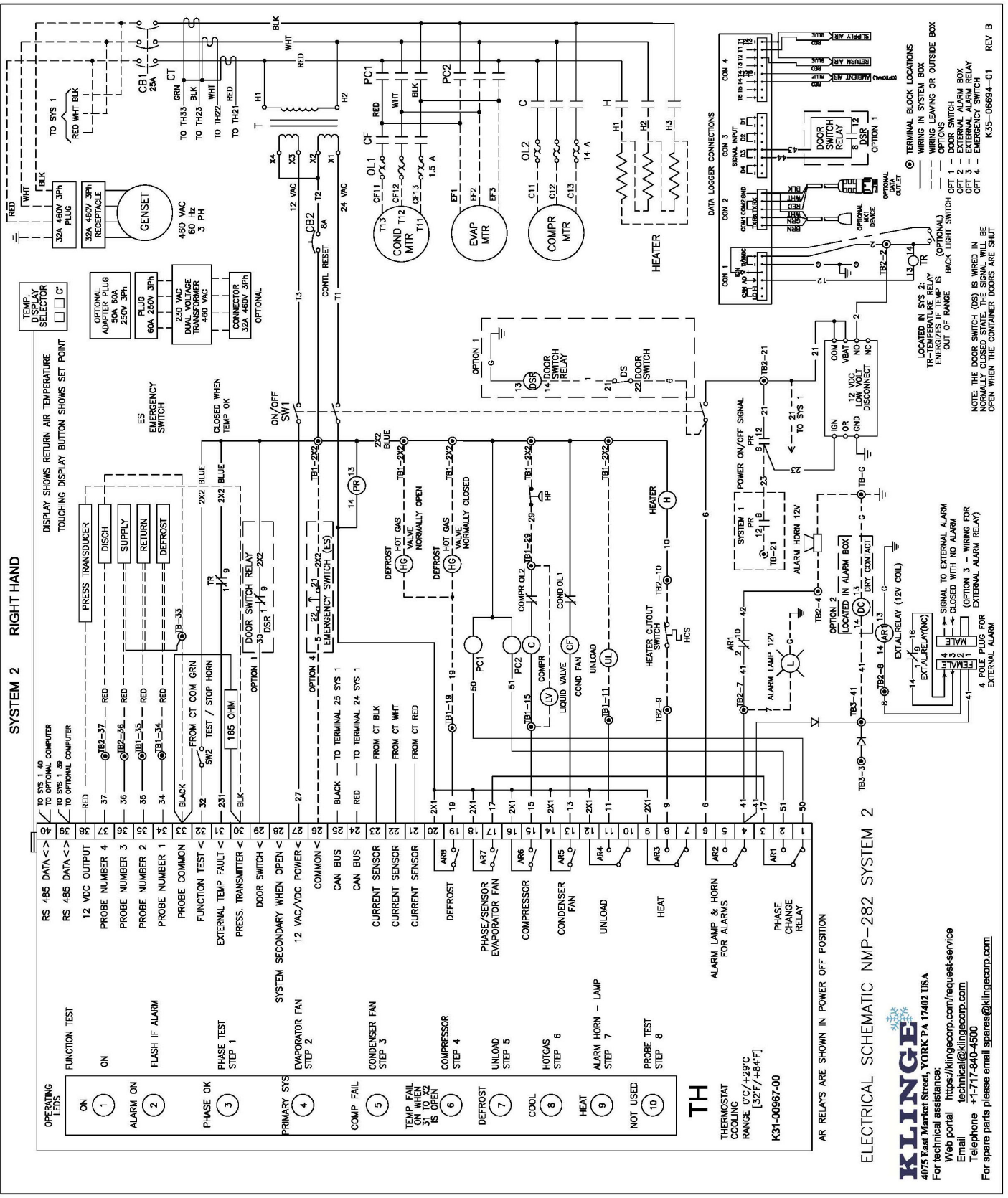

OPERATING LEDS	FUNCTION TEST
ON 1	RS 485 DATA <->
ALARM ON 2	RS 485 DATA <-> TO SYSTEM 1
PHASE OK 3	12 VDC OUTPUT TO OPTIONAL COMPUTER
PRIMARY SYS 4	PROBE NUMBER 4
COMP FAIL 5	PROBE NUMBER 3
TEMP. FAIL 6	PROBE NUMBER 2
DEFROST 7	PROBE NUMBER 1
COOL 8	PROBE COMMON
HEAT 9	FUNCTION TEST <->
NOT USED 10	EXTERNAL TEMP FAULT <->

ELECTRICAL SCHEMATIC NMP-282 SYSTEM 2

KLINGE
 4075 East Market Street, YORK PA 17402 USA
 For technical assistance:
 Web portal: <https://kingcorp.com/request-service>
 Email: technical@kingcorp.com
 Telephone: +1-717-840-4500
 For spare parts please email spares@kingcorp.com

SECTION SIX - TROUBLE SHOOTING

6.1 GENERAL INFORMATION

Several components are incorporated into the unit to assist the serviceman in finding the cause of problems concerning the operation of the unit.

LED indicators are located on the front edge of the thermostat to indicate functions and modes that should be operating.

To indicate alarms the ALARM LED will flash, and an ALARM CODE will be shown in the display.

On the side of the thermostat and adjacent to each output relay are red LED indicators to show which output relay (AR1 through AR8) is energized.

These indicators along with discharge and suction pressure gauges attached by the serviceman can be used to determine if certain cycles are operating. Compressor and fan operation can be determined by sound. Defrost hot gas solenoid operation normally is audible, but feel may be required if there is too much background noise.

6.2 THERMOSTAT LED INDICATIONS

DURING FUNCTION TEST

Use label on the side of the thermostat. (Reference Section 2.5)

DURING OPERATION

Use label on front edge of thermostat (Reference Section 4.4)

6.3 SERVICE COMPONENTS

- A. Sight glasses - mounted in the liquid receiver to determine if the refrigerant charge is correct. Check the system refrigerant charge at 32°F (0°C) container temperature. The lower receiver sight glass is also a moisture indicator, used to determine if moisture is in the system. (See Section 5.2, 5.3 & 5.4).
- B. Filter drier - a dirty, clogged filter can be detected by a noticeable temperature change between the filter inlet tube and its outlet tube.

6.4 TROUBLE SHOOTING CHART

The following trouble shooting chart is by no means complete, but covers the more general type of problems, which would be most likely if a breakdown is experienced. Also see the alarm codes (Section 6.5) for more help.

PROBLEM	POSSIBLE CAUSE	CORRECTIVE ACTION SUGGESTED	
Power to unit but unit will not start	CB2 Tripped	Reset	
	CB1 Tripped	Reset	
	No control circuit voltage at T1	Check primary side for 480V @ T1	
		Check for proper connections at T1	
		Replace T1 if defective	
No control circuit voltage at thermostat	Faulty SW1, replace SW1 T27 to T26 (12V), T20 to T26 (24V)		
Thermostat will not function test	No voltage (12V) between T27 & T32 when SW2 is depressed	Faulty SW2, replace SW2	
	Faulty thermostat	Replace	
Compressor will not run	Compressor contactor "C" coil faulty	Replace contactor or mechanical failure of contactor	
	High Pressure switch (HP) open	Remedy reason for high discharge pressure	
	Discharge pressure too high	Remedy reason for high discharge pressure	
	Defective HP switch	Replace	
	Open compressor windings due to thermal protection switch being open	Remedy cause of overheating	
	Open compressor windings when compressor is cool	Replace compressor	
	Current overload OL3 is open	Determine cause of high current draw and remedy	
	OL3 not adjusted for auto reset	Adjust to auto reset	
	Compressor trips CB1, but does not run due to mechanical restriction	Replace compressor	
	System is in secondary mode	Normal (should not run)	
Evaporator fan does not run	Faulty current sensor or controller	Replace	
	"PC1" or "PC2" phase changing contactor faulty	Replace contactor	
	Motor internal thermal protection open or windings open	Replace motor	
	OL2 overload open	Motor amperage too high, replace fan motor	
	Faulty OL2	Replace	
Secondary evaporator fan does not run	Secondary system not turned on	Turn on	
	CB2 of secondary system tripped	Reset	
	Temperature is @ set point	Normal	

Condenser fan and evaporator fans do not run		See - Evaporator fans DO NOT RUN
Condenser fan only will not run	"CF" condenser fan contactor faulty	Replace
	OL1 overload open	Motor amperage too high, replace fan motor
	Faulty OL1	Replace
One of the 2 fans runs backwards, same system	Motor or condenser fan, "CF" contactors may be mis-wired	Correct wiring
No hot gas for defrosting	Coil of HG valve faulty	Replace coil
	Mechanical fault in valve body	Replace valve
	Compressor not running	See-Compressor will not run problems
Unit runs on 480V but not on 230V	Dual voltage transformer faulty or mis-wired	Replace dual voltage transformer or correct wiring
	Faulty 230V plug or faulty 480V connector	Replace or repair
Box temperature too high	Return air probe circuit open	Check wiring; replace probe
	Faulty thermostat	Replace
Box temperature too low	Return air probe circuit shorted	Check wiring; replace probe
	Faulty thermostat	Replace
Defrost too often	Air flow too low or no air flow	Check evaporator fans for operation and rotation
Defrost duration too long	Too little hot gas	See - NO HOT GAS FOR DEFROSTING
	Defrost probe not in proper location	Locate probe correctly
Cooling capacity problem	Refrigerant level too low	Check & add refrigerant if required
	Partially or completely blocked filter drier	Check & replace
	Low airflow, fans not running or not running in the proper direction	Check & correct
	Non-condensable (air) in refrigerant system	Purge condenser coil and receiver
	Faulty TXV	Replace
	One or both kazoos missing from condensate hose	Install where required
	Hot gas leaking through Hg valve	Replace valve
	Severe lube oil overcharge	Remove excess oil. Check oil level. (Allow oil level to be within sight glass when compressor is hot and has been running for 10 to 15 minutes)
Compressor mechanical problem reducing pumping capacity	Replace defective compressor	
Alarm lamp fails to light	Bulb burn out	Replace bulb
	No 12V DC battery power	Check battery & correct problem
	Faulty SW1	Replace switch

Alarm horn fails to sound	No 12V DC battery power	Check battery & correct problem
	Faulty horn	Replace
	Faulty SW1	Replace switch
	Temperature recorder inoperative	Repair or replace
Battery does not get charged while operating on house power	Battery charger in L.H. electrical box failed	Replace
	Transformer T2 in L.H. box failed or is mis-wired	Replace T2 or correct wiring
	Circuit breaker CB3 is tripped	Reset

6.5 ALARM CODE

Alarm **LED** indicators are reset if control system power is turned **OFF**.

ALARM CODE	ALARM NAME	ALARM CONDITION	ALARM ACTION	ALARM CLEAR	SUGGESTION FOR REPAIR	ALARM LEVEL (HIGH = SYSTEM CHANGEOVER)
A01	Defrost sensor short	The sensor or the wire to the sensor is shorted.	LED 2 will flash. AR 2 will de-energize.	If there has not been an alarm for 60 minutes, then the controller clears the alarm. Or by C/F key.	Replace sensor. Check wire for damage.	High
A02	Defrost sensor open	The sensor or the wire to the sensor is open.	LED 2 will flash. AR 2 will de-energize.	If there has not been an alarm for 60 minutes, then the controller clears the alarm. Or by C/F key.	Replace sensor. Check wire for damage.	High
A03	Return sensor short	The sensor or the wire to the sensor is shorted.	1: Controller switches over and use defrost sensor to read container temperature. 2: If defrost sensor is open or short, then if set point is > -7°C, then unit stops. If set point < -7°C, then unit runs 100% cool all time. LED 2 will flash. AR 2 will de-energize.	If there has not been an alarm for 60 minutes, then the controller clears the alarm. Or by C/F key.	Replace sensor Check wire for damage.	High
A04	Return sensor open	The sensor or the wire to the sensor is shorted.	1: Controller switches over and use defrost sensor to read container temperature. 2: If defrost sensor is open or short, then if set point is > -7°C then unit stop. If set point < -7°C, then unit run 100% cool all time. LED 2 will flash. AR 2 will de-	If there has not been an alarm for 60 minutes, then the controller clears the alarm. Or by C/F key.	Replace sensor Check wire for damage.	High

			energize.			
A05	Supply sensor short	The sensor or the wire to the sensor is shorted.	LED 2 will flash. AR 2 will de-energize.	If there has not been an alarm for 60 minutes, then the controller clears the alarm. Or by C/F key.	Replace sensor Check wire for damage.	High
A06	Supply sensor open	The sensor or the wire to the sensor is open.	No action.	No action.	Replace sensor Check wire for damage.	High
A07	Compressor sensor short	The sensor or the wire to the sensor is shorted.	Compressor runs without any safety at the compressor discharge temperature. LED 2 will flash. AR 2 will de-energize.	If there has not been an alarm for 60 minutes, then the controller clears the alarm. Or by C/F key.	Replace sensor Check wire for damage.	High
A08	Compressor sensor open	The sensor or the wire to the sensor is open.	No action.	No action.	Replace sensor Check wire for damage.	High
A09	Pressure transmitter out of range.	The sensor or the wire to the sensor is defective.	No action	If there is a pressure transmitter on the unit, then display C/F key clears the alarm. Else no action.	Replace sensor Check wire for damage.	Low
A11	Phase sensor fail	The sensor cannot find the 3 phase at the main power. (Test is performed at unit start up)	The unit will stop, and every 5 minutes the controller will test the sensor to see if the sensor is ok. LED 2 will flash. AR 2 will de-energize.	If the sensor passes a new test, then the controller clears the alarm. Or by C/F key.	Check Main power Check evaporator fan. Check condenser Fan. Check CT sensor. Check wire for damage.	High
A14	Low current on evaporator fan	The fan motor is using too little power. (Test is performed at unit start up and at system changeover)	LED 2 will flash. AR 2 will de-energize.	Display C/F key clears the alarm	Check if relay is switched on. Check output from controller.	Low

A15	High current on evaporator fan	The fan motor is using too much power. (Test is performed at unit start up and at system changeover)	LED 2 will flash. AR 2 will de-energize.	Display C/F key clears the alarm	Check amps at evaporator fan motor. Check if fan is rotating.	Low
A16	Low current on condenser fan	The condenser fan is using too little power. (Test is performed at unit start up and at system changeover)	LED 2 will flash. AR 2 will de-energize.	Display C/F key clears the alarm	Check if relay is switched on. Check output from controller.	Low
A17	High current on condenser fan	The condenser fan is using too much power. (Test is performed at unit start up and at system changeover)	LED 2 will flash. AR 2 will de-energize.	Display C/F key clears the alarm	Check amps at condenser motor. Check if fan is rotating.	Low
A18	Low current on compressor	The compressor is using too little power. (Test is performed at unit start up and at system changeover)	LED 2 will flash. AR 2 will de-energize.	If there has not been an alarm for 60 minutes, then the controller clears the alarm. Or by C/F key.	Check if relay is switched on. Check overload relay. Check output from controller. Check gas at the ref. system. Check if HP is switched out.	Low
A19	High current on compressor	The compressor is using too much power. (Test is performed at unit start up and at system changeover)	LED 2 will flash. AR 2 will de-energize.	If there has not been an alarm for 60 minutes, then the controller clears the alarm. Or by C/F key.	Check amps at compressor motor.	Low
A20	Different current on heating elements	The heater elements are drawing different amounts of current	LED 2 will flash. AR 2 will de-energize.	Display C/F key clears the alarm	Check heaters for shorts of if relay is missing a phase.	Low

A21	Different current on evaporator fan motor	There is a difference between the phases. (Test is performed at unit start up and at system changeover)	LED 2 will flash. AR 2 will de-energize.	Display C/F key clears the alarm	Check if relay is missing a phase. Check if voltage is too low. Check the motor element for defect with a clamp ammeter	Low
A22	Different current on condenser fan	There is a difference between the phases. (Test is performed at unit start up and at system changeover)	LED 2 will flash. AR 2 will de-energize.	Display C/F key clears the alarm	Check if relay is missing a phase. Check if voltage is too low. Check the motor element for defect with a clamp ammeter	Low
A23	Different current on compressor	There is a difference between the phases. (Test is performed at unit start up and at system changeover)	LED 2 will flash. AR 2 will de-energize.	If there has not been an alarm for 60 minutes, then the controller clears the alarm. Or by C/F key.	Check if relay is missing a phase. Check if voltage is too low. Check the motor element for defect with a clamp ammeter	Low
A24	Compressor unload fail	If compressor current is not dropping when the unload valve is on, then there will be an alarm. (Test is performed at unit function test)	LED 2 will flash. AR 2 will de-energize.	Display C/F key clears the alarm	Check controller output. Check unload valve.	Low
A29	Temperature sensor difference too large under test.	Difference between the temperature sensors is too large. (Test is performed at unit function test)	LED 2 will flash. AR 2 will de-energize.	Display C/F key clears the alarm	Check sensors for correct reading.	Low

A30	Container temperature too low	<p>If the rate of temperature change is too slow, less than 0.06 °C / hour, (i.e. not heating fast enough) and the return probe temperature is outside of a 2°C window of the set point there is an alarm.</p> <p>OR if the return probe temperature has been inside a 2 °C window of set point at some time since power up or since the set point was changed, and if the return air temperature is outside a 2°C window of set point for 2 hours or more, there is an alarm.</p>	LED 6 will flash, and LED 2 will flash. AR 2 will de-energize.	<p>If the return air is inside the 2°C window of the set point, then the controller clears the alarm.</p> <p>Or by C/F key.</p>	<p>Check hot gas system Check evaporator fan motor Check air flow. Check container door is closed.</p>	High
A31	Container temperature too high	<p>If the rate of temperature change is too slow, less than 0.06 °C / hour, (i.e. not cooling fast enough) and the return probe temperature is outside of a 2°C window of the set point there is an alarm.</p> <p>OR if the return probe temperature has been inside a 2 °C window of set point at some time since power up or since the set point was changed, and if the return air temp is</p>	LED 6 will flash, and LED 2 will flash. AR 2 will de-energize.	<p>If the return air is inside the 2°C window of the set point, then the controller clears the alarm.</p> <p>Or by C/F key.</p>	<p>Check refrigerant gas. Check TX valve. Check evaporator fan motor. Check air flow. Check compressor. Check if condenser is dirty. Check condenser fan motor. Check container door is closed.</p>	High

		outside a 2°C window of set point for 2 hours or more, there is an alarm.				
A32	Defrost time too long	The defrost cycle lasts longer than one hour	The defrost will stop, and the unit will go back to normal operation. LED 2 will flash. AR2 will de-energize.	The alarm is clear by display C/F key.	Check hot gas valve. Check refrigerant gas. Check compressor.	High
A33	Evaporator temperature too low	If the controller calls for a defrost less than 30 minutes after last defrost end. (the delta T between the return air and the defrost probe is too large)	Unit will run cooling mode until 90 minutes after last defrost end. LED 2 will flash. AR2 will de-energize.	The alarm is clear by display C/F key.	Check evaporator fan motor. Check airflow. Check if fins at evaporator coil are bent. Check door to container is closed. Check defrost and return sensors for correct reading.	Low
A34	Compressor temperature too high	If the compressor sensor is above 120°C	Unit will stop until compressor sensor is below 90°C, or the alarm is reset.	If there has not been an alarm for 60 minutes, then the controller clears the alarm. Or by C/F key.	Check refrigerant gas. Check if there is air in the refrigeration system. Check if condenser is dirty. Check condenser fan motor.	High

A35	External temperature fail	These conditions will produce an open at terminal 31. If terminal 31 has been open in 60 minutes, then the alarm is set.	LED 6 will flash, and LED 2 will flash. AR 2 will de-energize.	The alarm is clear by display C/F key	Check setting of temperature alarm recorder. Check evaporator fan motor. Check gas on system. Check TX valve. Check hot gas system. Check container door is closed.	High
A36	High pressure cut out. Cool mode	If there has been 3 HP cut out in an hour when the unit is in cool mode, then the alarm will be set to on.	LED 2 and LED 4 will flash. AR 2 will de-energize.	The alarm is clear by display C/F key	Check condenser fan motor is running. Check if condenser needs cleaning. Check if there is air in the gas system. Check adjustment of suction regulator valve. Check HP switch for fault.	High
A37	High pressure cut out. Hot gas mode	If there has been 3 HP cut out in an hour when the unit is in hot gas mode, then the alarm will be set to on.	LED 2 and LED 4 will flash. AR 2 will de-energize.	The alarm is clear by display C/F key.	Check if condenser coil needs cleaning. Check hot gas solenoid valve for proper orientation. Check hot gas solenoid head for proper orientation. Check for	Low

					proper refrigerant charge. Check evaporator coil is free of ice or blockage. Make sure suction and discharge regulators are set correctly.	
A41	Set point different from Sys 1 to Sys 2.	If the set points of the (2) systems are more than 1°C out of sync with each other than alarm will activate	LED 2 and alarm code on display	Adjusting the set point temperature to within 1°C of each other automatically clears	N/A	N/A
A42	No response from system to system	Unit will display alarm if only one unit is powered ON for more than 3 minutes	LED 2 and alarm code on display	Turn ON the second unit and alarm will automatically clear, or allow to operate as is, if necessary.	N/A	Low
A44	Container door open	Container door open timer exceeded	LED 2 will flash. AR 2 will de-energize.	Close container door or turn unit OFF	Close container door or turn unit OFF	Low
A49	Set point error flash bank error	Unit will display alarm if set point is not loaded in controller	Control will not start up before a set point is put into the controller.	The alarm is clear by putting set point in controller.	This is normally if new software is uploaded to the controller.	High

- Low Level A Low Level Alarm will give the Alarm Number on the Touch Pad. The alarm lamp will light, and the horn will sound.
- High Level A High Level Alarm will give the Alarm Number on the Touch Pad. The alarm lamp will light, and the horn will sound. The unit will switch over to the backup system.

6.6 DATA LIST

Electrical	
All data are approx. and based on 480 volt/60 Hz.	
Input power	480 volts,3 phase 60Hz
Current total unit. (1 system running with 2 evap fans)	Full load - 17 Amps
Compressor motor.	1700 Rpm - full load – 11.0 Amps
Condenser motor.	1700 Rpm - full load – 1.2 Amps
Evaporator motor.	3400 Rpm - full load – 1.5 Amps
CB1	25 Amps
OL1 setting	1.5 Amps
OL2 setting	16 Amps

Refrigerant System	
System charging R-134a	3.4 kg
Compressor oil charge.	2.7 Liter (91.5 fl oz)
High-pressure switch, R-134a. (cannot be adjusted)	Cut-out approx. 19 bar +/-0.7 (290 Psig +/- 10) Cut-in approx. 13.3 bar +/-0.7 (200 Psig +/- 10)
Crankcase pressure regulator	Set to suction pressure at max. 3 bar = 43.5 Psig
Safety Relief valve	32.75 bar = 475 Psig

6.7 PTI FORM

It is important that a Pre-Trip Inspection (PTI) be completed prior to each shipment.

The NMP-282 PTI form can be found on Klinge's website at: <http://www.klingecorp.com/pti/>

6.8 LOADING CONFIGURATION

Placement of cargo within the container must be considered for optimum airflow and uniform temperatures for protection of the cargo.

Best practices for container cargo loading can be found on Klinge's website at: <http://www.klingecorp.com/cargoloading/>

SECTION SEVEN - SERVICE PARTS

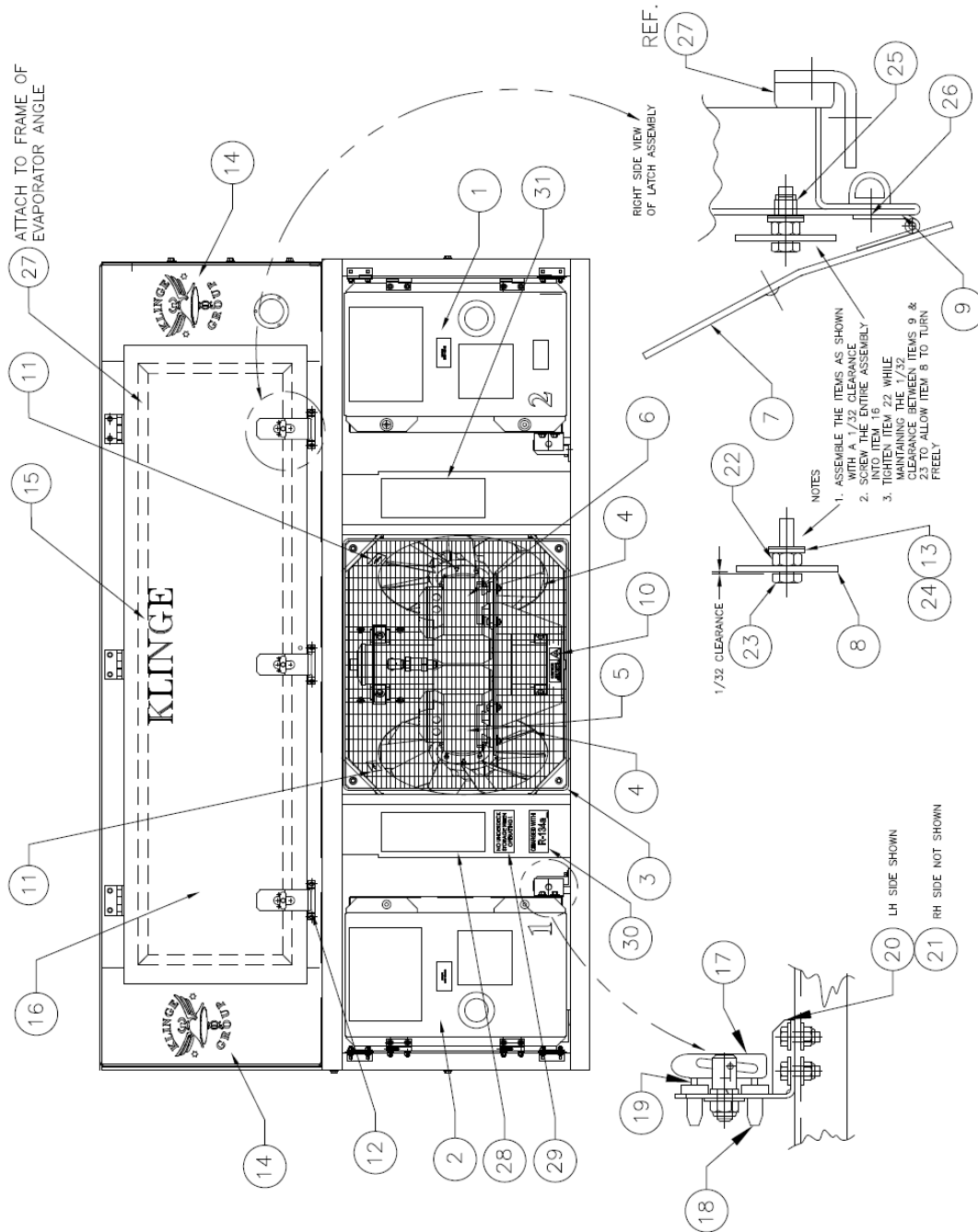

SECTION 7.1
UNIT FRONT VIEW

7.1 UNIT FRONT VIEW

ITEM	PART NO.	DESCRIPTION	QTY
1	360-18386-00	ELECTRICAL CONTROL BOX RIGHT COMPLETE	1
2	360-18385-00	ELECTRICAL CONTROL BOX LEFT COMPLETE	1
3	360-16773-00	GRILL RECTANGLE 30 X 10, 650MM X 580 MM	1
4	K26-72467-01	FAN 10 BLADE 19 MM BORE 425 MM DIA	2
5	360-17818-00	ASSY COND FAN MOTOR SYS 1	1
6	360-17818-01	ASSY COND FAN MOTOR SYS 2	1
7	360-07969-00	LATCH WELDED PASSIVATED & POLISHED	3
8	060-07971-00	KNOB PASSIVATED & POLISHED	3
9	K28-10873-00	INSULATOR LATCH	3
10	K35-04602-03	LABEL CAUTION FAN STARTS AUTOMATICALLY	1
11	K35-05606-00	LABEL ARROW 1" X 2"	2
12	060-07964-00	KEEPER DOOR LATCH PASSIVATED & POLISHED	3
13	K21-18510-06	WASH INSUL PVC M6	3
14	K35-51577-00	LABEL LOGO KLINGE GROUP DARK BLUE	2
15	K35-05743-01	LABEL KLINGE BLUE	1
16	360-10817-10	DOOR EVAPORATOR ASSEMBLY	1
		(INCLUDES ITEMS 7, 8, 9, 13, 15, 22 THRU 26)	
17	K21-16315-00	FASTENER BABY ANTILUCE M8 X 1.25	2
18	K28-10848-03	PLUG BUMPER .5 DIA X 1.25 LONG	4
19	060-12494-00	PIN NYLON BLACK 3/16 DIA	4
20	060-10832-00	SUPPORT ELECTRICAL BOX RETAINER L.H.	1
21	060-10833-00	SUPPORT ELECTRICAL BOX RETAINER R.H.	1
22	K21-50103-06	NUT HEX SS M6 X 1	3
23	K21-50224-25	SCREW HEX SS M6 X 1 X 25	3
24	K21-16547 06	WASHER FLAT SS M6 6.4 X 18 X 1.6 18-8 LARGE OD	3
25	K21-16478-05	NUT INSERT LF CBRS M6 X 1 165	3
26	K21-15910-04	RIVET SS 3/16 (.12-.25)	6
27	K28-10232-00	GASKET DOOR EVAPORATOR	1
28	K35-05906-02	LABEL OPERATION OF TEMPERATURE SELECTOR	1
29	K35-06656-00	LABEL "NO UNDERDECK STORAGE WHEN OPERATING"	1
30	K35-05782-05	LABEL "CHARGED WITH R-134a"	1
31	K35-06679-03	LABEL ALARM CODES	1

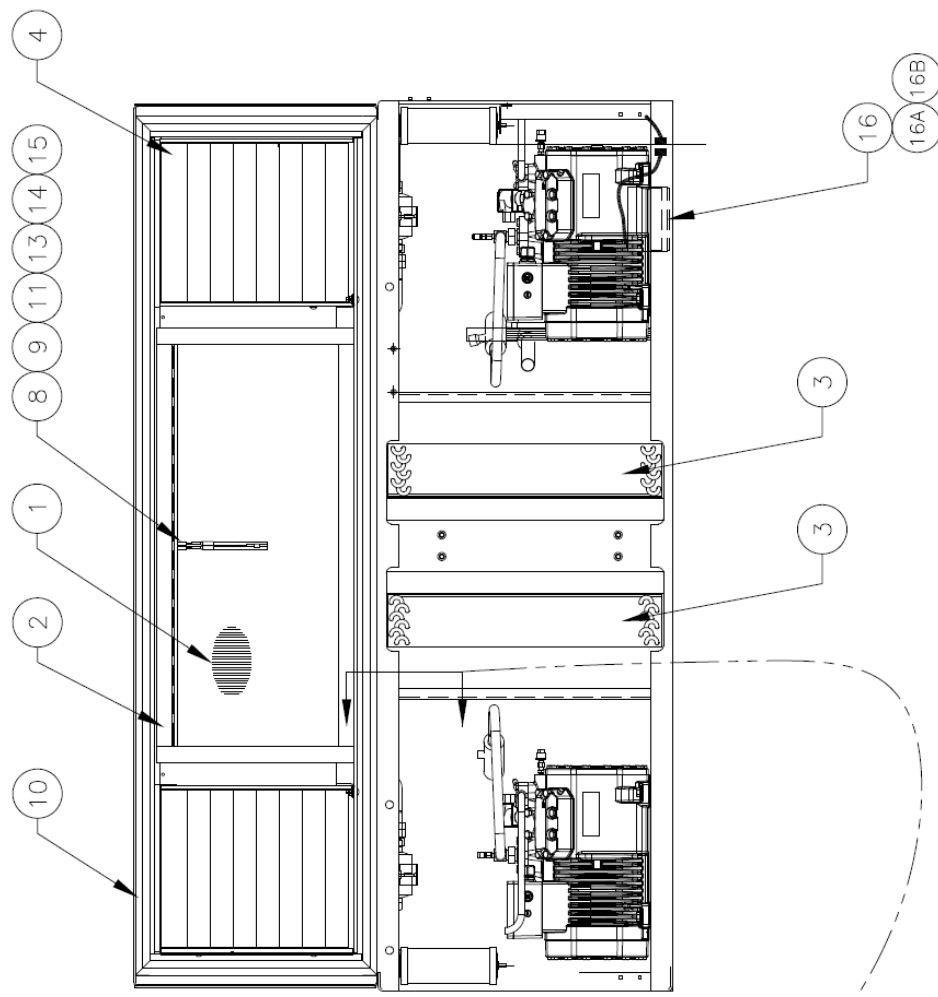

EVAPORATOR DRAIN
2 PLACES

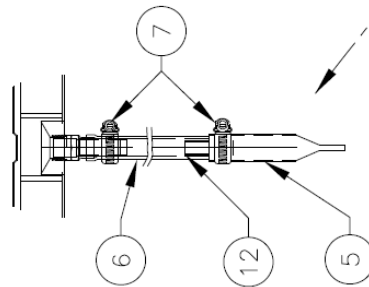

SECTION 7.2
UNIT REAR VIEW

7.2 UNIT REAR VIEW

ITEM	PART NO.	DESCRIPTION	QTY
1	K26-24888-00	COIL EVAPORATOR ½ TUBE DUAL	1
2	060-15554-00	GASKET EVAP GRILL	1
3	K26 25246 00	COIL COND RIGHT AND LEFT	2
4	360-11138-00	LOUVER EVAPORATOR DISCHARGE	16
5	060-02709-00	TUBE KAZOO EPDM 1.5 X 9	2
6	060-02708-00	TUBE PLSTC PBC ¾ ID X 1 OD X 78 LG	2
7	K21-16231-00	CLAMP HOSE .75 – 1.5	4
8	360-17625-00	ASSEMBLY RETURN AIR PROBE	1
		(INCLUDES ITEMS 9, 11, 13, 14, AND 15)	
9	360-17621-00	PROBE HOLDER	1
10	K28-10913-00	GASKET EVAPORATOR D/D 19-1/8 X 76	1
11	360-17812-00	PROBE RETURN EUROSCAN	1
12	060-01417-00	TUBE CU 5/8 X .035 WALL X 2.06 LONG	2
13	360-11153-00	PROBE RETURN AIR TEMP	2
14	K28-10847-02	GROMMET INSERT .625 MTG HOLE	1
15	360-17812-01	PROBE RETURN SPARE EUROSCAN	1

ITEMS BELOW ARE ONLY USED WHEN REFRIGERATION UNIT IS TO BE STATIONARY
WITH **NO GENSET**

ITEM	PART NO.	DESCRIPTION	QTY
16	360-14320-00	KIT BATTERY INSTALLATION STATIONARY	1
		(INCLUDES 14A AND 14B)	
16A	360-14319-00	CABLE BATTERY STATIONARY	1
16B	360-13517-00	ASSEMBLY BATTERY RECHARGEABLE 12V	1

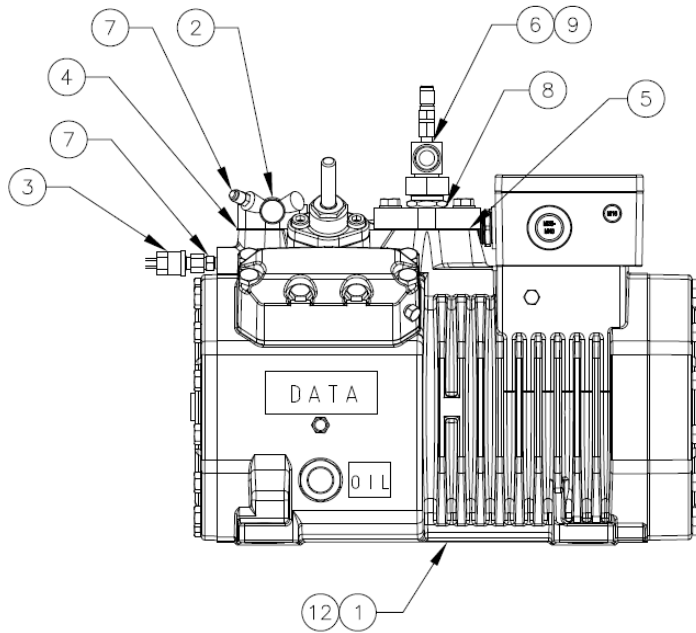
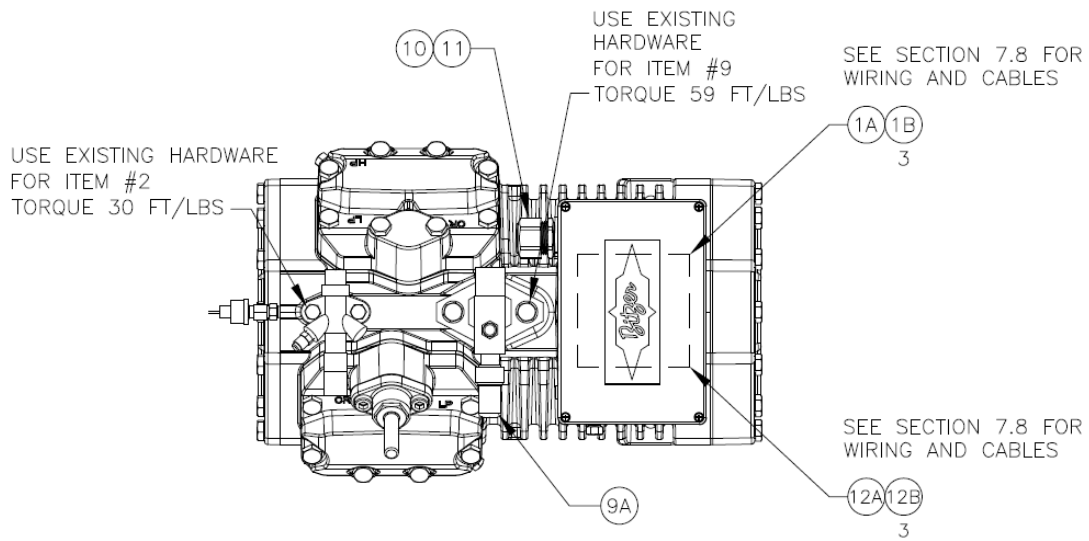

SECTION 7.3
COMPRESSOR

7.3 COMPRESSOR

ITEM	PART NO.	DESCRIPTION	QTY
1	360-18394-01	COMPRESSOR ASSEMBLY 4 CYL BITZER LEFT HAND	1
		(INCLUDES ITEMS 1A, 1B, 2, 4, 5, 6,7, 8, 9, 10, AND 11)	
1A	K35-06699-01	LABEL ELECT HOOK-UP COMPRESSOR LEFT HAND	1
1B	K28-11067-21	CAPLUG VINYL RED .218 ID X 1" HIGH	3
2	K22-06954-00	VALVE COMPR DISCH BRS 5/8 C 2 HOLES 1.62 CENTERS ODS	1
3	K25-20869-00	CONTROL HP NC OPEN 290 PSI CLOSE 200 PSI	1
4	K21-50401-10	GASKET COMPR VALVE 2 HOLE 1.62 CENTERS	2
5	K28-10889-00	GASKET DISCHARGE 2 HOLE 2.625 CENTERS	1
6	K28-04836-00	GASKET SEAL TEFLON 1" OD .88" ID	1
7	K22-06907-00	VALVE BRASS SCHRADER STRAIGHT 1/8" MPT	2
8	360-11191-01	BLOCK DISCHARGE ROTA 1-1/4 BLACK	1
9	K22-06910-00	VALVE ROTA 1 1/4-12 X 7/8 C BRASS ANGLE TOP PORT	1
		(INCLUDES ITEM 9A)	
9A	K22-06972-00	CAP VALVE SUCTION BLACK PLASTIC	1
10	K25-26761-26	CONNR STR PLST M25 (12,2-18,0 mm)	1
11	K25-26147-02	SEAL RING PLASTIC 3/4 "	1
12	360-19394-02	COMPRESSOR ASSEMBLY 4 CYL BITZER RIGHT HAND	1
		(INCLUDES ITEMS 12A, 12B, 2, 3, 4, 5, 6,7, 8, 9, 10, AND 11)	
12A	K35-06699-02	LABEL ELECT HOOK-UP COMPRESSOR LEFT HAND	1
12B	K28-11067-21	CAPLUG VINYL RED .218 ID X 1" HIGH	3

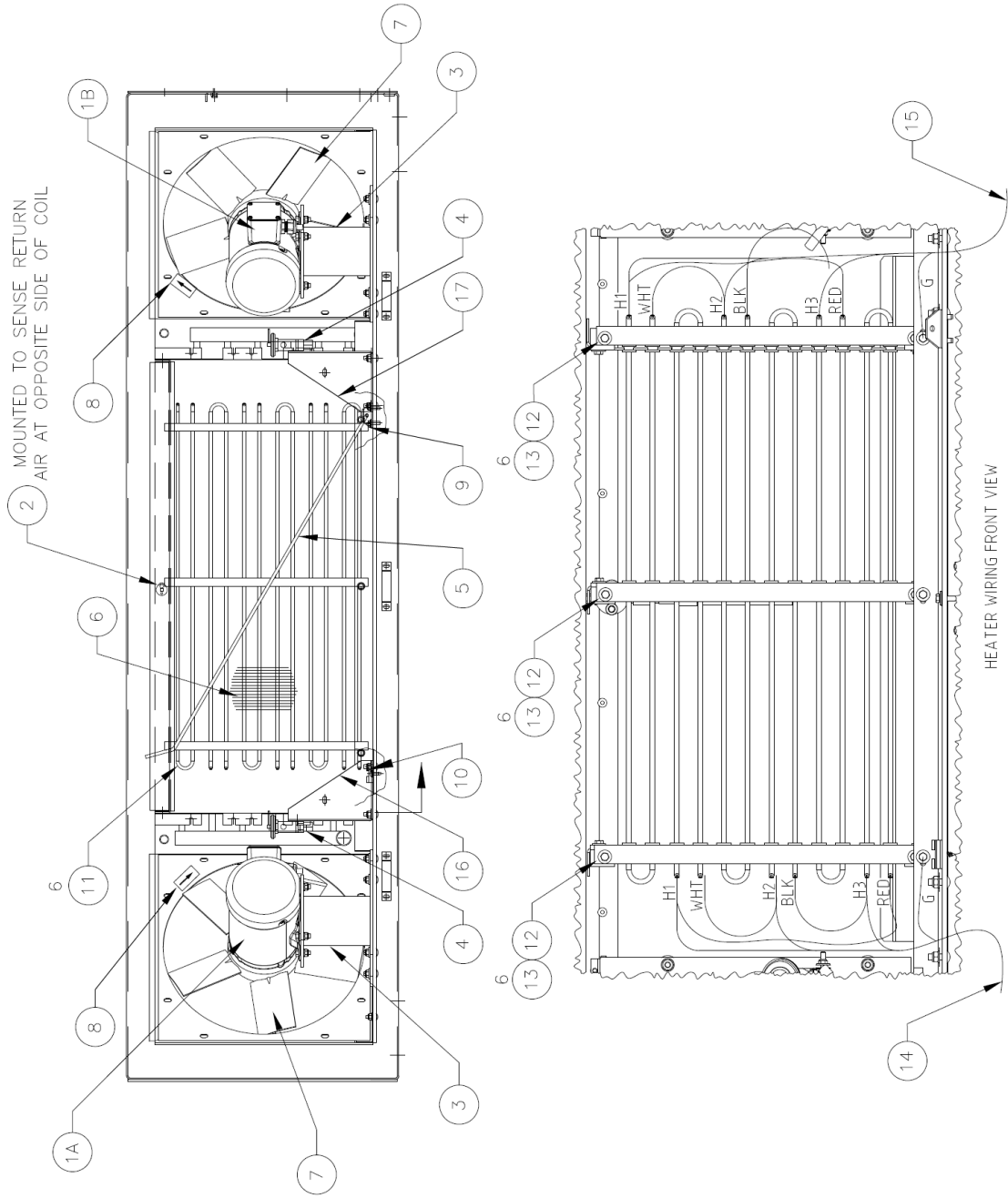

SECTION 7.4
EVAPORATOR VIEW

7.4 EVAPORATOR VIEW

ITEM	PART NO.	DESCRIPTION	QTY
1A	360-18516-01	MOTOR EVAPORATOR 3/4 HP	1
1B	360-18516-02	MOTOR EVAPORATOR 3/4 HP	1
2	360-13807-01	KIT PROBE 6" RETURN-DEFROST	4
3	360-11140-00	BASE MOTOR EVAPORATOR FAN	2
4	K25-26982-00	VALVE TX 1/2 X 7/8 X 1/4	2
5	060-06456-00	ROD SUPPORT EVAPORATOR COVER	1
6	K26-24888-50	COIL EVAPORATOR 1/2 TUBE DUAL	1
7	K26-25156-01	FAN 16 DIA 14 DEG 1/2 BORE 5 GRP BLD TAPPER H BUSH CW R	2
8	K35-05606-00	LABEL ARROW 1" X 2"	2
9	060-06457-00	BRACKET DOOR SUPPORT	1
10	060-06458-00	CLIP RETAINING	1
11	K25-26886-00	HEATER 440V 1500W	6
12	060-18486-00	RETAINER FAN HEATER	3
13	K25-26970-00	INSULATOR CERAMIC HEATER BUSHING 3/4" DIA X 5/16" HOLE	36
14	360-18396-01	CABLE HEATER SYSTEM 1	1
15	360-18396-02	CABLE HEATER SYSTEM 2	1
16	360-18397-01	CABLE HEATER CUT-OUT SWITCH SYSTEM 1	1
17	360-18397-02	CABLE HEATER CUT-OUT SWITCH SYSTEM 2	1

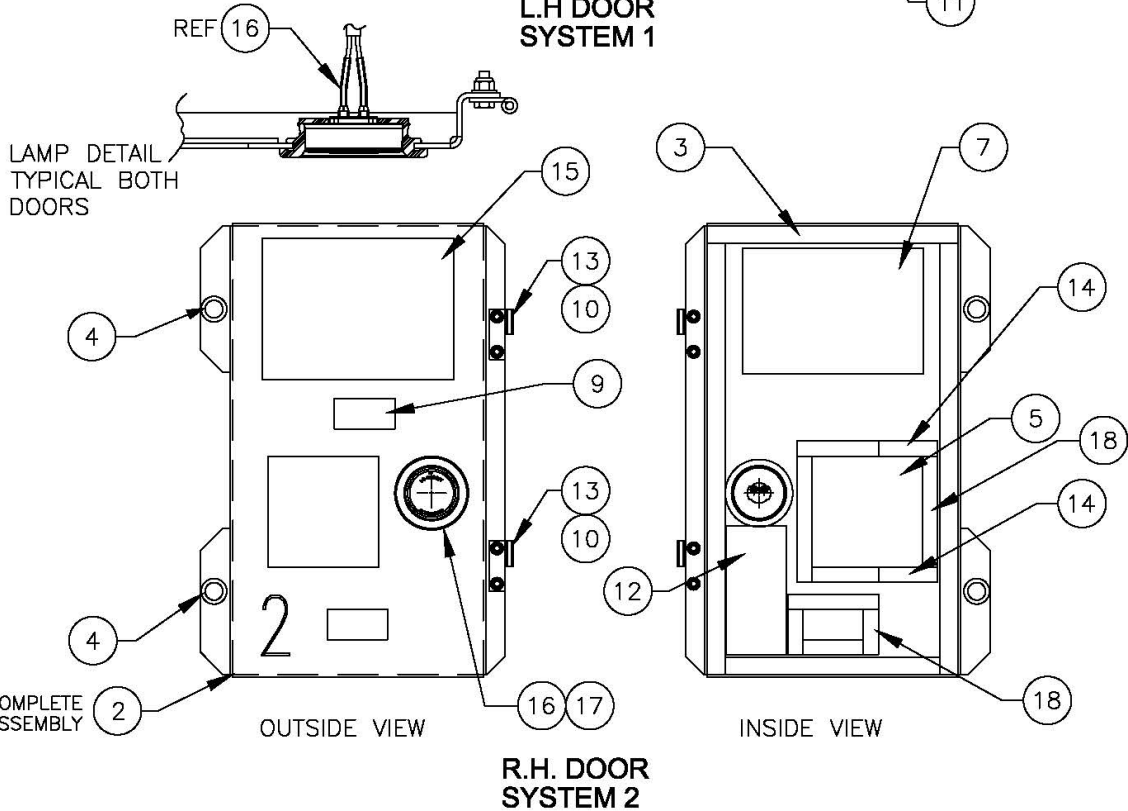
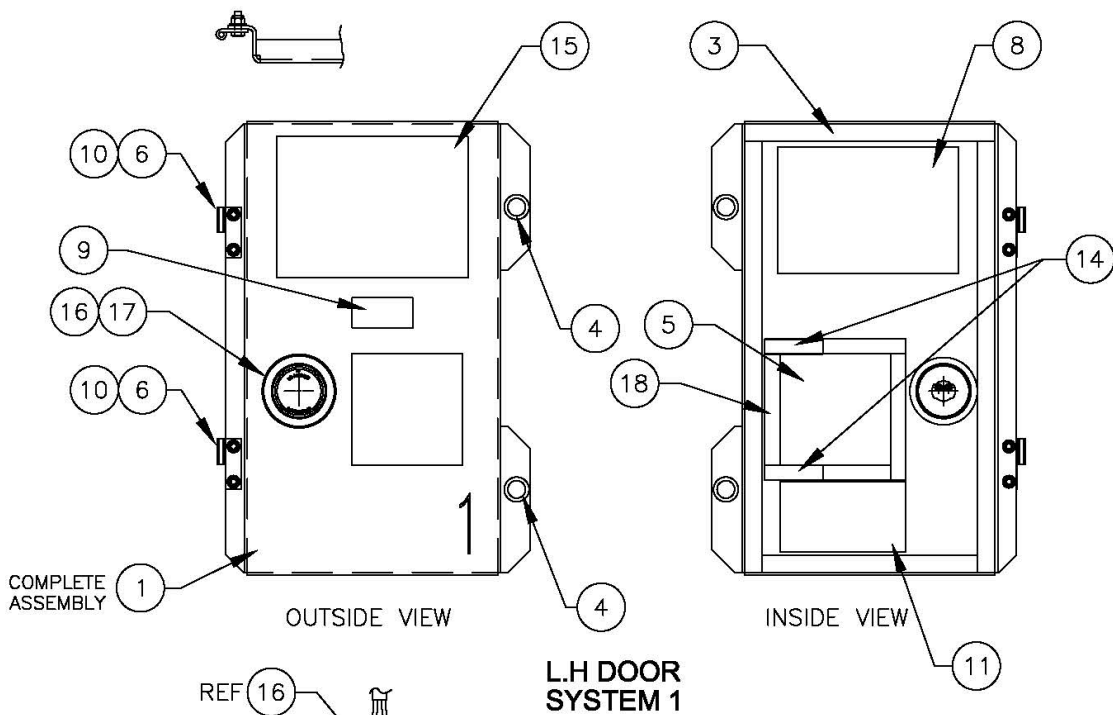

SECTION 7.5
L.H. & R.H. ELECTRICAL BOX DOOR VIEW

7.5 ELECTRICAL BOX DOORS

ITEM	PART NO.	DESCRIPTION	QTY
1	360-18391-00	DOOR ELECT BOX COMPLETE LEFT	1
2	360-18392-00	DOOR ELECT BOX COMPLETE RIGHT	1
3	K28-10813-00	STRIP SPONGE 3/8" X 7/8" SOFT CLOSE CELL	11.3 FT
4	K28-10847-04	GROMMET INSERT .875 HOLE SIZE	4
5	K28-10849-20	WINDOW ELECTRICAL BOX	2
6	K29-17880-01	HINGE SLIP LEFT-HAND	2
7	K35-06694-01	LABEL ELECT SCHEMATIC RIGHT SYS 2	1
8	K35-06693-01	LABEL ELECT SCHEMATIC LEFT SYS 1	1
9	K35-05899-00	LABEL DANGER HIGH VOLTAGE	2
10	060-09113-00	INSULATOR HINGE	4
11	K35-06696-00	LABEL COMPONENT LAYOUT LH ELECT BOX	1
12	K35-06697-01	LABEL COMPONENT LAYOUT RH ELECT BOX	1
13	K29-17879-01	HINGE SLIP RIGHT-HAND	2
14	K28-09446-00	STRIP SPONGE 3/4" X 1" W/ADHESIVE X 63.5mm [2.50"]	4
15	K35-05905-08	LABEL OPERATING INSTRUCTIONS	2
16	360-15285-00	LAMP ALARM RED WITH CABLE	2
17	K28-11052-00	GROMMET ALARM LAMP BLACK VINYL	2
18	K13-02951-00	TAPE 3M VHB 3/4" WIDE	4.1 FT

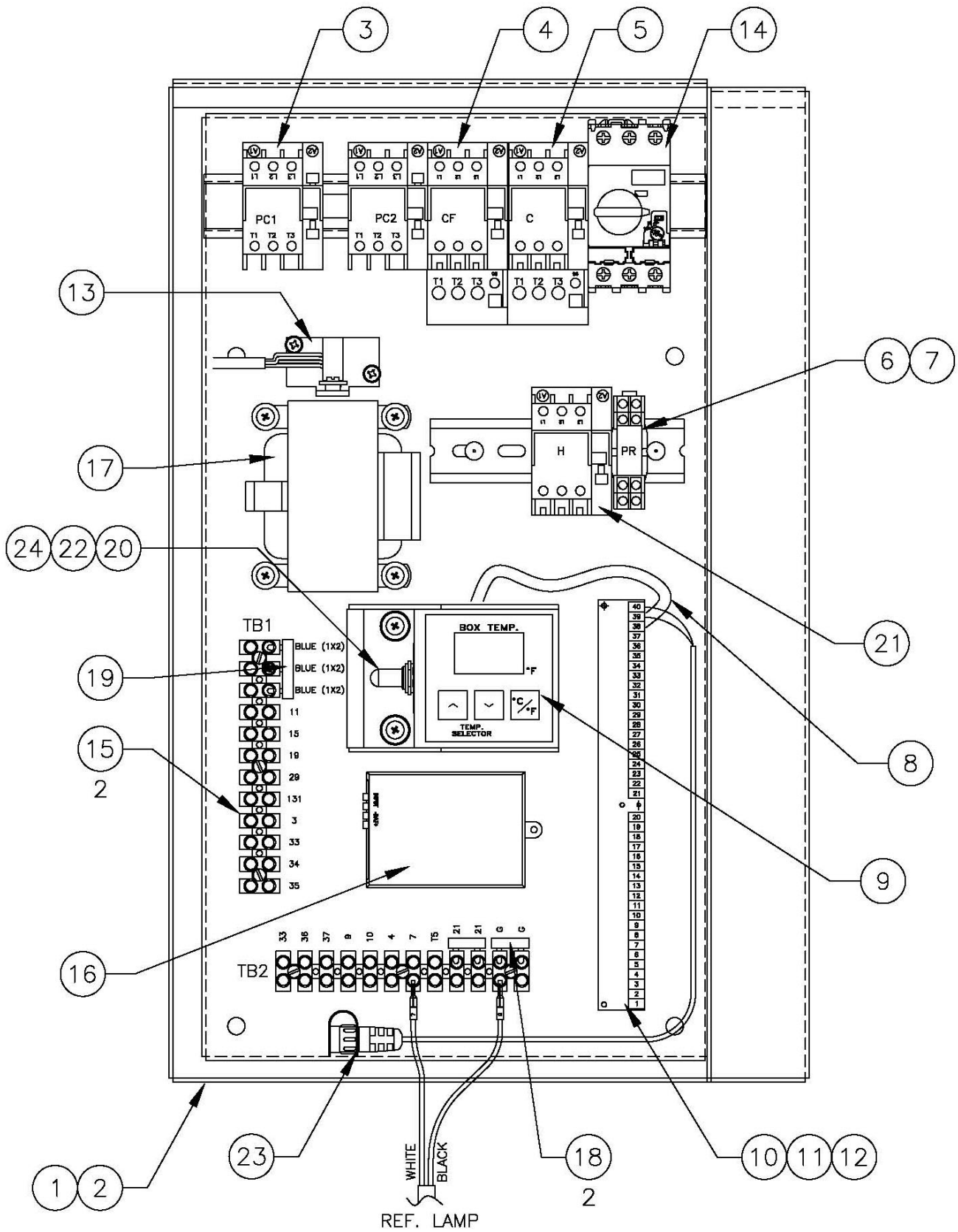

SECTION 7.6A
LEFT HAND (SYSTEM 1) ELECTRICAL BOX
INSIDE VIEW

7.6A LEFT-HAND (SYSTEM 1) ELECTRICAL BOX INTERIOR

ITEM	PART NO.	DESCRIPTION	QTY
1	360-18385-00	ELECTRICAL CONTROL BOX LEFT COMPLETE (INCLUDES ITEM 2 THROUGH 34)	1
2	360-10745-52	BOX PAINTED ELECTRIC LH	1
3	K24-22148-00	CONTACTOR REVERSING 9A 6P 24V	1
4	K24-22223-00	STARTER 9A 3P 24VAC (1.2-1.9 OL)	1
5	K24-22437-01	STARTER 25A 3P 24VAC (11-16 OL)	1
6	K25-26265-02	SOCKET RELAY DPDT 1/8 DIN MTG	1
7	K24-22264-03	RELAY 24 VAC MINI DPDT 3 AMPS	1
8	360-12540-03	CABLE RIBBON SHIELDED 10"	1
9	K31-00811-00	DISPLAY TEMPERATURE AND SELECTOR F/C	1
10	K31-00967-00	THERMOSTAT NMP-282	1
11	360-10829-00	BASE THERMOSTAT GREEN 5 PIECE WITH LABELS (INCLUDES ITEM 12)	1
12	K25-26139-00	HOLDER CARD 4 GREEN (SET)	1
13	360-16398-00	CURRENT SENSING TRANSFORMER 20A 3PH VERTICAL	1
14	K24-22363-25	CIRCUIT BREAKER IEC 3 POLE 19-25A	1
15	K25-26488-12	BLOCK TERM STRIP 12P 45A	2
16	360-15580-01	BATTERY CHARGER MODIFY	1
17	K25-26624-10	TRANSFORMER 230VA 400V 24/14V	1
18	K25-26550-02	JUMPER TERM STRIP 8-18GA 02 PL	2
19	K25-26550-03	JUMPER TERM STRIP 8-18GA 03 PL	1
20	K21-22416-00	SWITCH SPST 12V 20A ON/OFF SCREW TERMINAL	1
21	K24-22155-00	CONTACTOR 9A 3P 24V 60/50 Hz COIL	1
22	K24-17239-00	BOOT TOGGLE SWITCH	1
23	360-17984-01	CABLE DOWNLOAD DATA FROM MPC4 TO PC BOX END	1
24	K35-06683-00	LABEL ON/OFF TEMP SWITCH	1

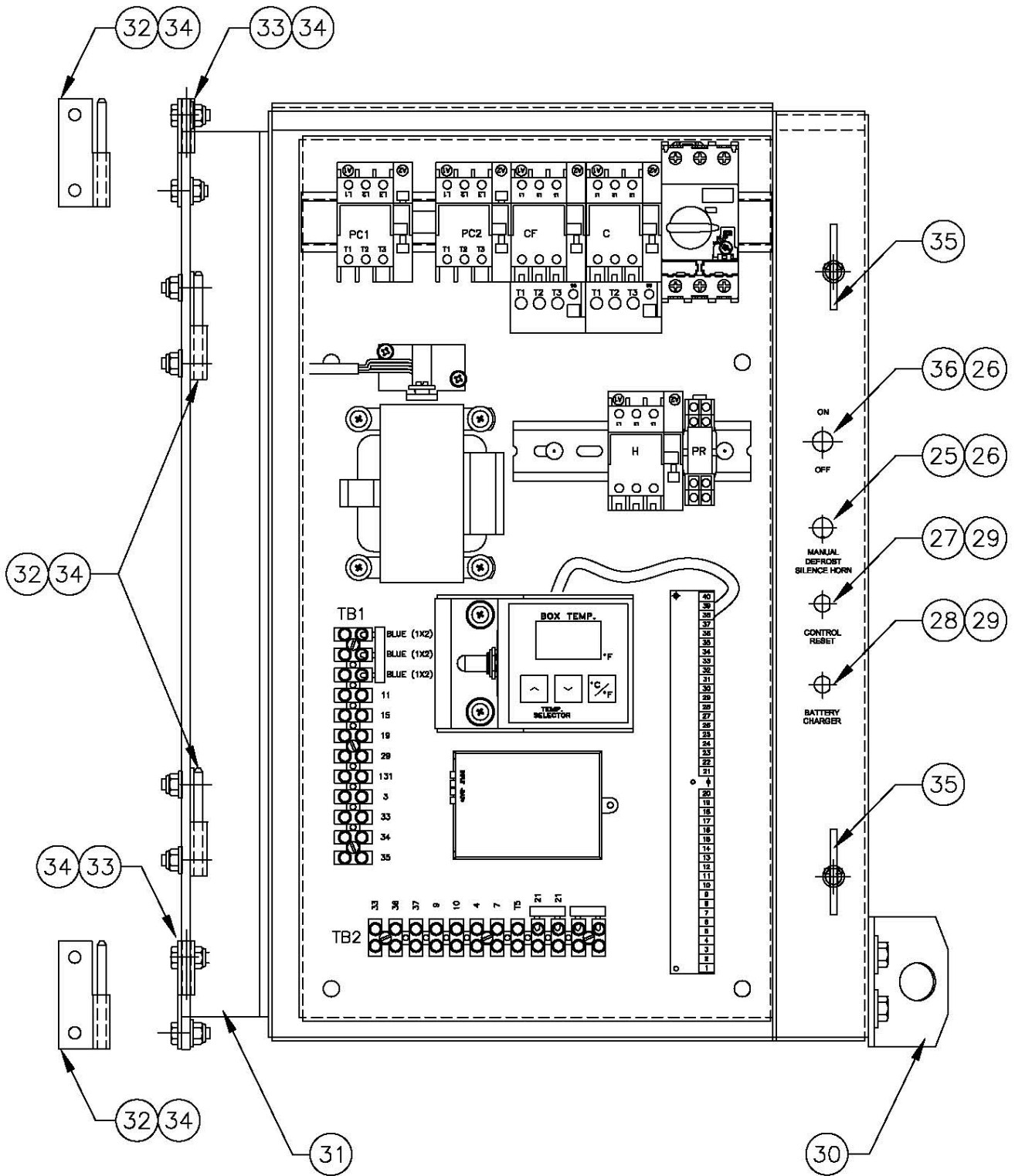

SECTION 7.6B
LEFT HAND (SYSTEM 1) ELECTRICAL BOX
OUTSIDE VIEW

7.6B LEFT-HAND (SYSTEM 1) ELECTRICAL BOX EXTERIOR

ITEM	PART NO.	DESCRIPTION	QTY
25	K24-21355-00	SWITCH TOGGLE SPDT ON	1
26	K24-17239-00	BOOT TOGGLE SWITCH FULL IP66/68	2
27	K24-20565-00	CIRCUIT BREAKER 8 AMP 1 POLE	1
28	K24-22330-00	CIRCUIT BREAKER 4 AMP 1 POLE	1
29	K24-18164-00	BOOT CIRCUIT BREAKER 3/8-27 THD CLEAR	2
30	060-10820-00	RETAINER ELECTRICAL BOX PASSIVATE & POLISH	1
31	060-10748-00	BRACKET HINGE ELECTRICAL BOX	1
32	K29-17879-02	HINGE SLIP SS 9/32 HOLES 2/PIN RIGHT-HAND	4
33	K29-17880-01	HINGE SLIP SS 9/32 HOLES SOCKET LEFT-HAND	2
34	060-09113-00	INSULATOR HINGE	6
35	K21-16313-00	FASTENER BABY ANTILUSE M8 X 1.25	2
36	K24-22144-00	SWITCH TOGGLE 3PST ON-OFF	1

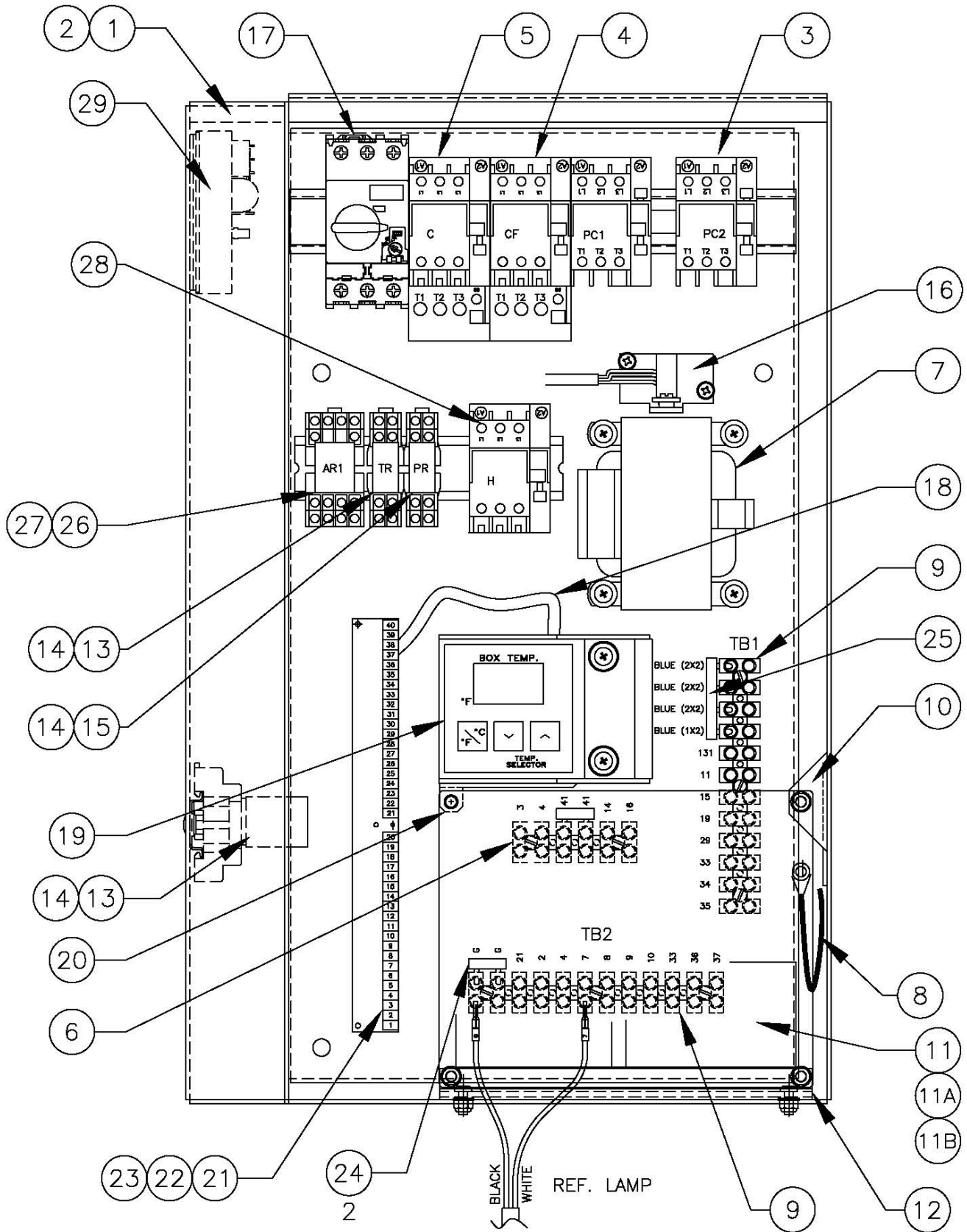

**SECTION 7.7A
RIGHT HAND (SYSTEM 2) ELECTRICAL BOX
INSIDE VIEW**

7.7A RIGHT-HAND (SYSTEM 2) ELECTRICAL BOX INTERIOR

ITEM	PART NO.	DESCRIPTION	QTY
1	360-18386-00	ELECTRICAL CONTROL BOX RIGHT COMPLETE	1
		(INCLUDES ITEM 2 THROUGH 39)	
2	360-10802-52	BOX PAINTED ELECTRICAL RH	1
3	K24-22148-00	CONTACTOR REVERSING 9A 6P 24V	1
4	K24-22223-00	STARTER 9A 3P 24VAC (1.2-1.9 OL)	1
5	K24-22437-01	STARTER 25A 3P 24VAC (11-16 OL)	1
6	K25-26488-06	BLOCK TERM STRIP 6P 45A	1
7	K25 26624-10	TRANSFORMER 230VA 400 V 24/14V	1
8	060-14326-00	CABLE LANYARD MOD 8" LONG	1
9	K25-26488-12	BLOCK TERM STRIP 12P 45A	2
10	360-14298-50	BRACKET DATA LOGGER	1
11	K31-00902-55	RECORDER TEMP AIR NO BOX W/LABEL	1
		(INCLUDES ITEMS 11A AND 11B)	
11A	K31-00903-16	PRINTER REPLACEMENT PART TX2 THERMAL	1
11B	K31-00903-03	PAPER PRINTER RECORDER	1
12	060-14268-00	HINGE MOUNTING RECORDER IN BOX	1
13	K24-22264-01	RELAY 12 VDC COIL MINI DPDT 3A	2
14	K25-26265-02	SOCKET RELAY DPDT 1/8 DIN MTG	3
15	K24-22264-03	RELAY 24 VAC MINI DPDT 3A	1
16	360-16398-00	CURRENT SENSING TRANSFORMER 20A 3PH VERTICAL	1
17	K24-22363-25	CIRCUIT BREAKER IEC 3 POLE 19-25A	1
18	360-12540-03	CABLE RIBBON SHIELDED 10"	1
19	K31-00811-00	DISPLAY TEMPERATURE AND SELECTOR F/C	1
20	360-14297-50	ASSEMBLY BRACKET RECORDER	1
21	K31-00967-00	THERMOSTAT NMP-282	1
22	360-10829-00	BASE THERMOSTAT GREEN 5 PIECE WITH LABELS	1
		(INCLUDES ITEM 23)	
23	K25-26139-00	HOLDER CARD 4 GREEN (SET)	1
24	K25-26550-02	JUMPER TERM STRIP 8-18GA 02 PL	2
25	K25-26550-04	JUMPER TERM STRIP 8-18GA 04 PL	1
26	K25-26265-00	SOCKET RELAY 4 PDT 1/8 DIN MTG	1
27	K24-22264-04	RELAY 12 VDC COIL MINI 4DPDT 5A	1
28	K24-22155-00	CONTACTOR 9A 3P 24V 60/50 Hz COIL	1
29	360-18288-00	REGULATOR VOLTAGE MODIFIED	1

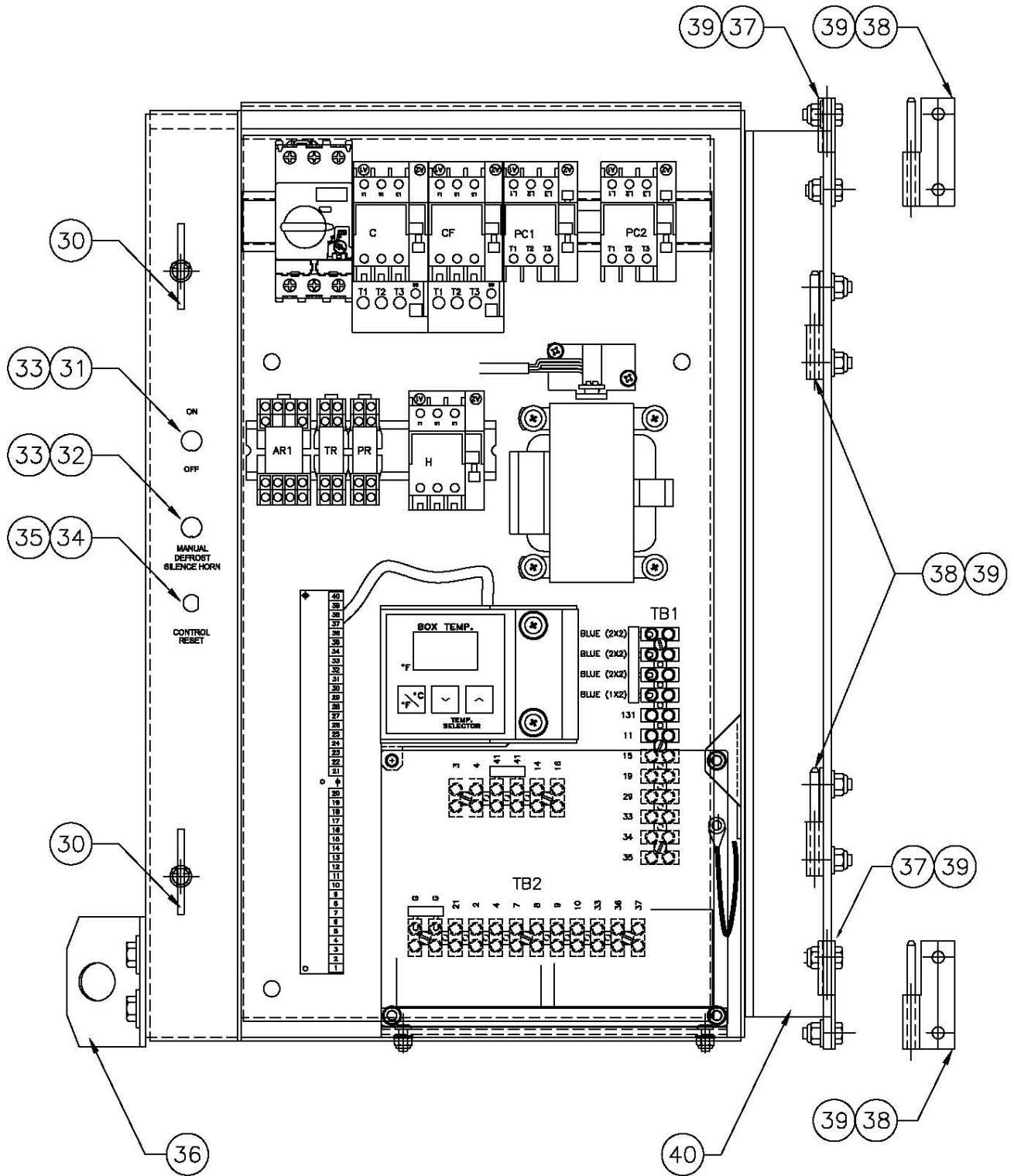

**SECTION 7.7B
RIGHT HAND (SYSTEM 2) ELECTRICAL BOX
OUTSIDE VIEW**

7.7B RIGHT-HAND (SYSTEM 2) ELECTRICAL BOX EXTERIOR

ITEM	PART NO.	DESCRIPTION	QTY
30	K21-16313-00	FASTENER BABY ANTILUSE M8 X 1.25	2
31	K24-22144-00	SWITCH TOGGLE 3PST ON-OFF	1
32	K24-21355-00	SWITCH TOGGLE SPDT ON	1
33	K24-17239-00	BOOT TOGGLE SWITCH FULL IP 66/68	2
34	K24-20565-00	CIRCUIT BREAKER 8 AMP 1 POLE	1
35	K24-18164-00	BOOT CIRCUIT BREAKER 3/8-27 THD CLEAR	1
36	060-10820-00	RETAINER ELECTRICAL BOX PASSIVATE & POLISH	1
37	K29-17879-01	HINGE SLIP SS 9/32 HOLES SOCKET RIGHT-HAND	2
38	K29-17880-02	HINGE SLIP SS 9/32 HOLES W/PIN LEFT-HAND	4
39	060-09113-00	INSULATOR HINGE	6
40	060-10748-00	BRACKET HINGE ELECTRICAL BOX	1
ITEMS BELOW FOR OPTIONAL AMBIENT RECORDER PROBE			
41	K25-26129-02	CONNECTOR PLASTIC SHORT 3/8"	1
42	K22-26340-01	NUT LOCK CONDUIT 3/8"	1

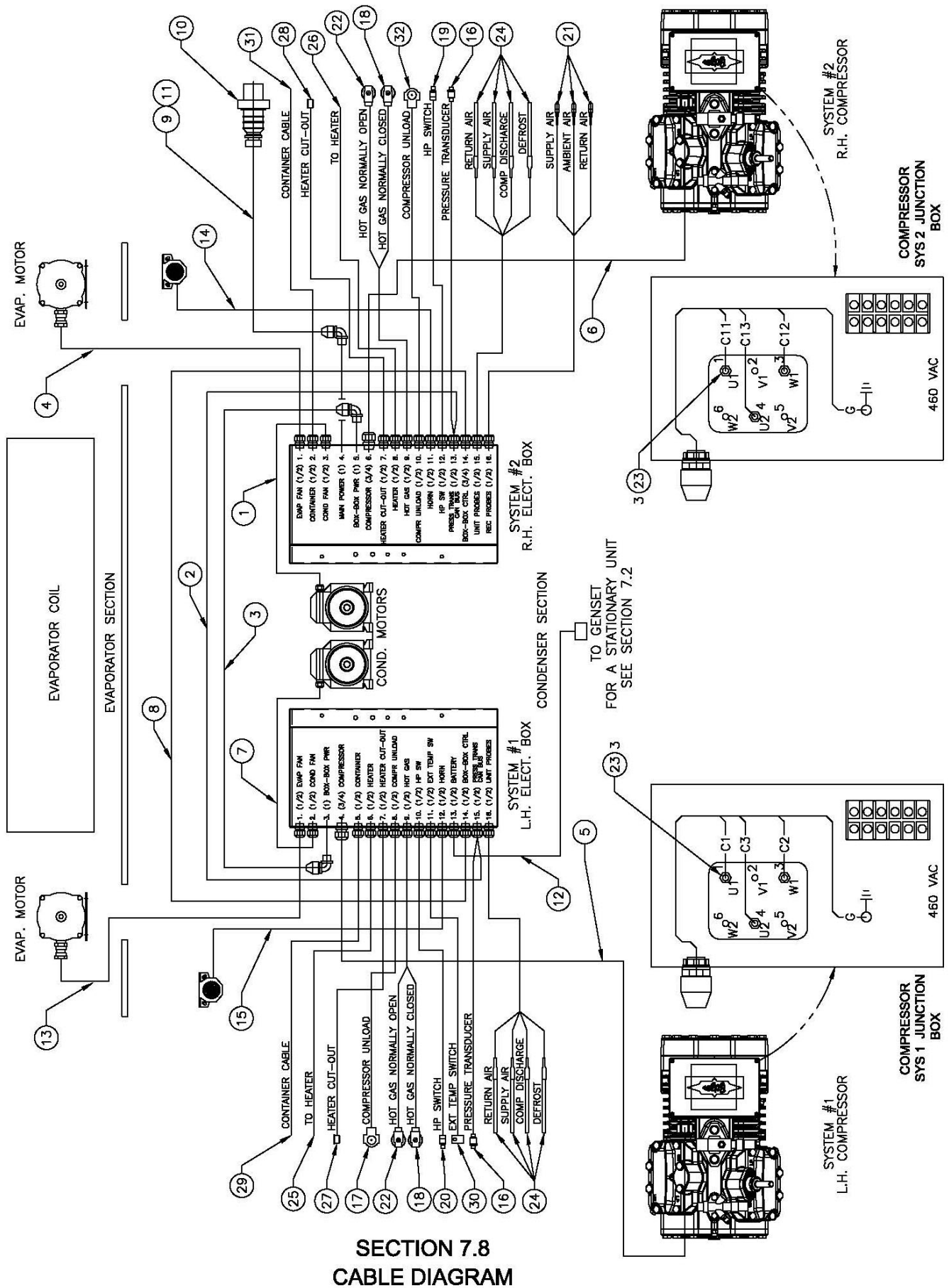

**SECTION 7.8
CABLE DIAGRAM**

7.8 CABLE DIAGRAM

ITEM	PART NO.	DESCRIPTION	QTY
1	360-17801-01	CABLE ASSY COND FAN SYS 2	1
2	360-17820-00	CABLE ASSY BOX TO BOX CAN BUS	1
3	360-17809-00	CABLE ASSY BOX TO BOX POWER	1
4	360-18517-02	CABLE ASSY EVAP FAN SYS 2	1
5	360-18520-01	CABLE ASSY COMP SYS 1	1
6	360-18520-02	CABLE ASSY COMP SYS 2	1
7	360-17801-00	CABLE ASSY COND FAN SYS 1	1
8	360-17821-00	CABLE ASSY BOX TO BOX CONTROL	1
9	360-17810-00	CABLE MAIN POWER 480 VOLTS 32 AMPRS 64 FT	1
		(INCLUDES ITEMS 10 & 11)	
10	K25-20474-00	PLUG POWER 32A 380/440V 3P+G	1
11	K25-19623-00	CORD ELEC SOOW 10/4 .70 OD 600V	64 FT
12	360-17807-00	CABLE ASSY GENSET BAT	1
13	360-18517-01	CABLE ASSY EVAP FAN SYS 1	1
14	360-17811-01	CABLE ASSY HORN SYS 2	1
15	360-17811-00	CABLE ASSY HORN SYS 1	1
16	360-17806-02	CABLE ASSY PRESS TRANS	2
17	360-17300-03	COIL SOLENOID COMPRESSOR UNLOADER LH	1
18	360-17300-04	COIL SOLENOID HOT GAS NC	2
19	360-18624-00	CABLE ASSY HIGH PRESS SYS 2	1
20	360-17805-00	CABLE ASSY HIGH PRESS SYS 1	1
21	360-14318-00	KIT PROBE UNIVERSAL RECORDER	3
22	360-17300-05	COIL SOLENOID HOT GAS NO	2
23	K28-11067-21	CAPLUG VINYL RED .218 ID X 1" HIGH	6
24	360-13807-00	KIT PROBE UNIVERSAL 6"	8
25	360-18396-01	CABLE HEATER SYSTEM 1	1
26	360-18396-02	CABLE HEATER SYSTEM 2	1
27	360-18397-01	CABLE HEATER CUT-OUT SWITCH SYSTEM 1	1
28	360-18397-02	CABLE HEATER CUT-OUT SWITCH SYSTEM 2	1
29	360-18655-02	CABLE CONTAINER LH BOX	1
30	360-18146-10	EXTERNAL TEMPERATURE SWITCH	1
31	360-18655-03	CABLE CONTAINER RH BOX	1
32	360-18623-00	CABLE ASSY UNLOAD LIQUID SOLENOID SYS 2	1

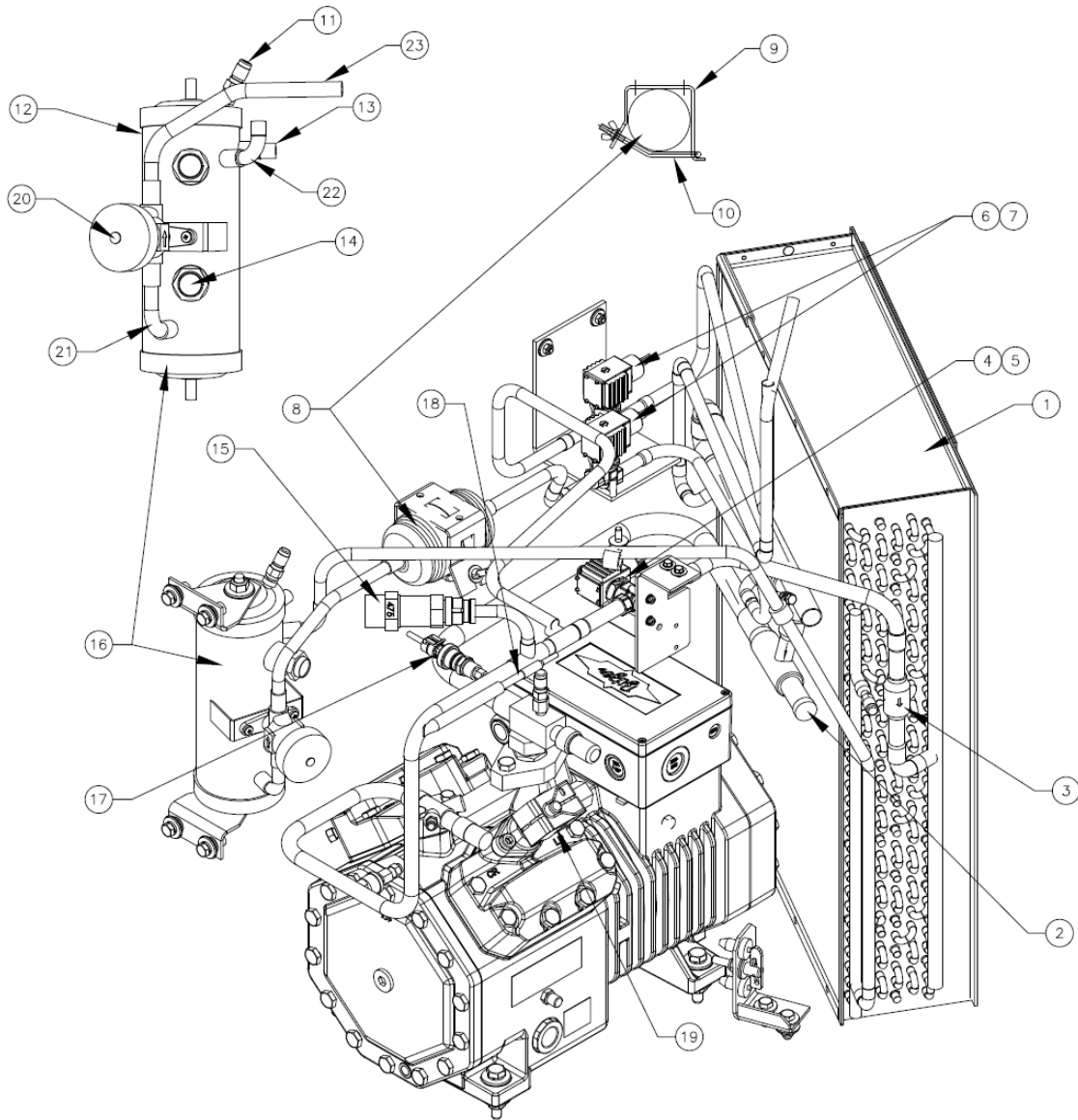

SECTION 7.9A
SYSTEM 1 CONDENSER PIPING

7.9A SYSTEM 1 CONDENSER PIPING

ITEM	PART NO.	DESCRIPTION	QTY
1	K26-25246-00	COIL CONDENSER RIGHT AND LEFT	1
2	K22-07026-00	VALVE REGULATOR CRANKCASE SUCTION LINE 7/8C X 7/8C	1
3	K26-58023-30	VALVE CHECK 5/8 ID BRASS	1
4	360-17300-05	COIL SOLENOID NORM OPEN 24 VAC	1
5	K25-26858-01	VALVE SOLENOID NORM OPEN	1
6	K25-26089-01	VALVE SOLENOID NORM CLOSED	2
7	360-17300-04	COIL SOLENOID NORM CLOSED 24 VAC	2
8	K26-10795-01	FILTER DRIER 1/2 C	1
9	060-06902-00	BRKT DRIER MTG	1
10	360-56093-00	BOLT DRIER MTG	1
11	K23-13238-00	ADPT 1/4 MFLR WITH CAP AND CU GASKET BRASS	1
12	K26-24871-01	RECEIVER LH EX 3.5 OD	1
13	K23-12987-00	PLUG FUSIBLE 1/4 MPT X 1/4 MFL	1
14	K26-25031-00	SIGHT GLASS	2
15	K22-07028-03	VALVE PRESSURE RELIEF 1/2 MPT X 3/4 MPT 475 PSIG	1
16	360-10737-05	RECEIVER LH WITH PIPE	1
		(INCLUDES ITEMS 11, 12, 13, 14, 20, 21, 22, & 23)	
17	360-17806-02	TRANSDUCER PRESSURE 0 TO 500 PSIG 4 TO 20 mA	1
18	K25-26097-00	PROBE TEMP .312 OD 10K THERMISTOR	1
19	360-17300-03	COIL SOLENOID VALVE 24V 50/60 Hz 14W	1
20	K22-01672-00	VAVLE HAND SHUT OFF 1/2 C BRASS	1
21	060-06639-00	CONN TUBE RECEIVER	1
22	K23-13142-02	ELL 90 CU LR 1/2 FTG X C	1
23	060-18471-00	TUBE 1/2 RECEIVER TO FILTER SYS 1 & 2	1

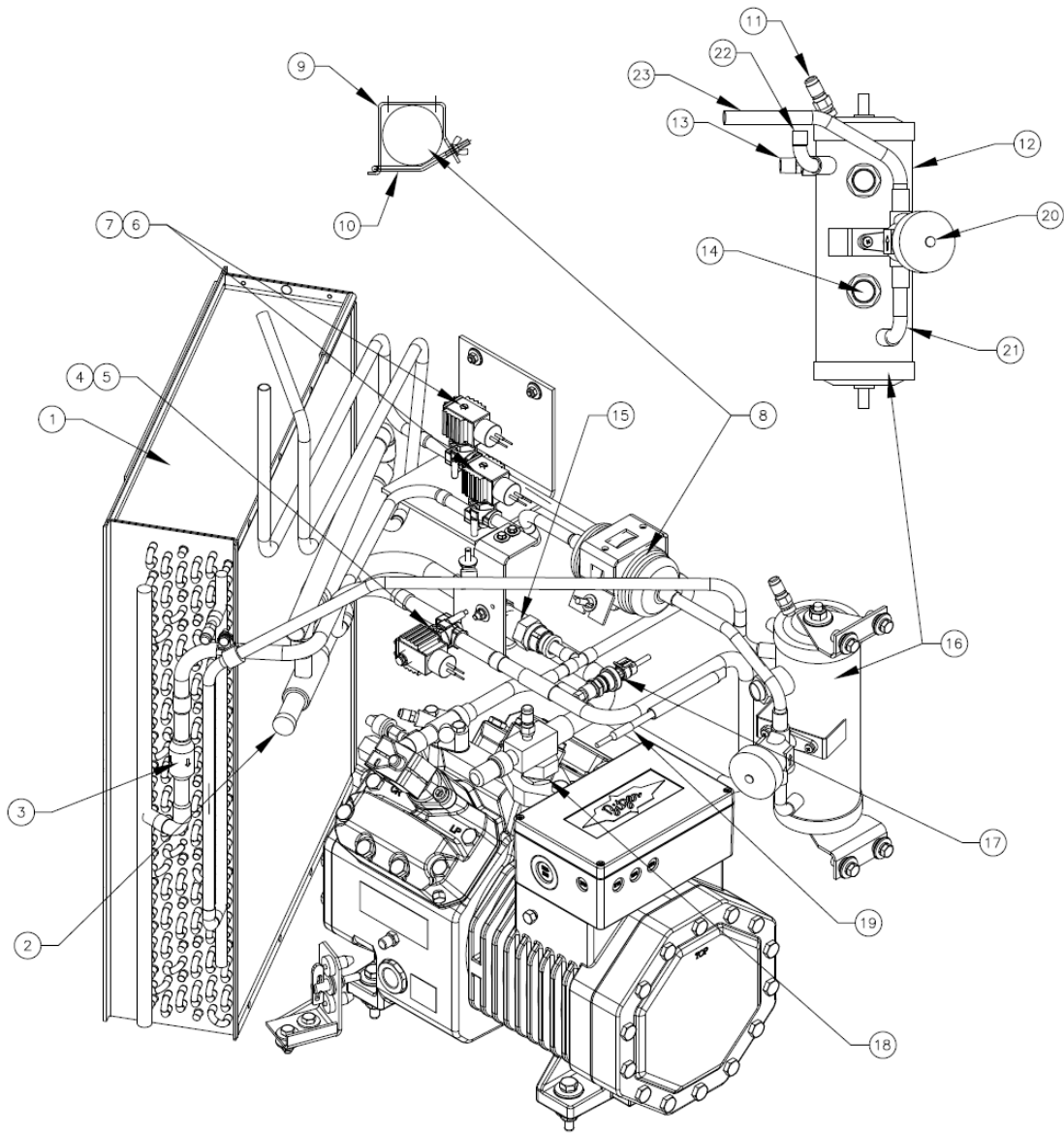

SECTION 7.9B
SYSTEM 2 CONDENSER PIPING

7.9B SYSTEM 2 CONDENSER PIPING

ITEM	PART NO.	DESCRIPTION	QTY
1	K26-25246-00	COIL CONDENSER RIGHT AND LEFT	1
2	K22-07026-00	VALVE REGULATOR CRANKCASE SUCTION LINE 7/8C X 7/8C	1
3	K26-58023-30	VALVE CHECK 5/8 ID BRASS	1
4	360-17300-05	COIL SOLENOID NORM OPEN 24 VAC	1
5	K25-26858-01	VALVE SOLENOID NORM OPEN	1
6	K25-26089-01	VALVE SOLENOID NORM CLOSED	2
7	360-17300-04	COIL SOLENOID NORM CLOSED 24 VAC	2
8	K26-10795-01	FILTER DRIER 1/2 C	1
9	060-06902-00	BRKT DRIER MTG	1
10	360-56093-00	BOLT DRIER MTG	1
11	K23-13238-00	ADPT 1/4 MFLR WITH CAP AND CU GASKET BRASS	1
12	K26-24872-01	RECEIVER RH EX 3.5 OD	1
13	K23-12987-00	PLUG FUSIBLE 1/4 MPT X 1/4 MFL	1
14	K26-25031-00	SIGHT GLASS	2
15	K22-07028-03	VALVE PRESSURE RELIEF 1/2 MPT X 3/4 MPT 475 PSIG	1
16	360-10738-05	RECEIVER RH WITH PIPE	1
		(INCLUDES ITEMS 11, 12, 13, 14, 20, 21, 22, & 23)	
17	360-17806-02	TRANSDUCER PRESSURE 0 TO 500 PSIG 4 TO 20 mA	1
18	K25-26097-00	PROBE TEMP .312 OD 10K THERMISTOR	1
19	360-17300-03	COIL SOLENOID VALVE 24V 50/60 Hz 14W	1
20	K22-01672-00	VALVE HAND SHUT OFF 1/2 C BRASS	1
21	060-06639-00	CONN TUBE RECEIVER	1
22	K23-13142-02	ELL 90 CU LR 1/2 FTG X C	1
23	060-18471-00	TUBE 1/2 RECEIVER TO FILTER SYS 1 & 2	1

UNIT SPLIT TO SHOW VIEW OF TUBING

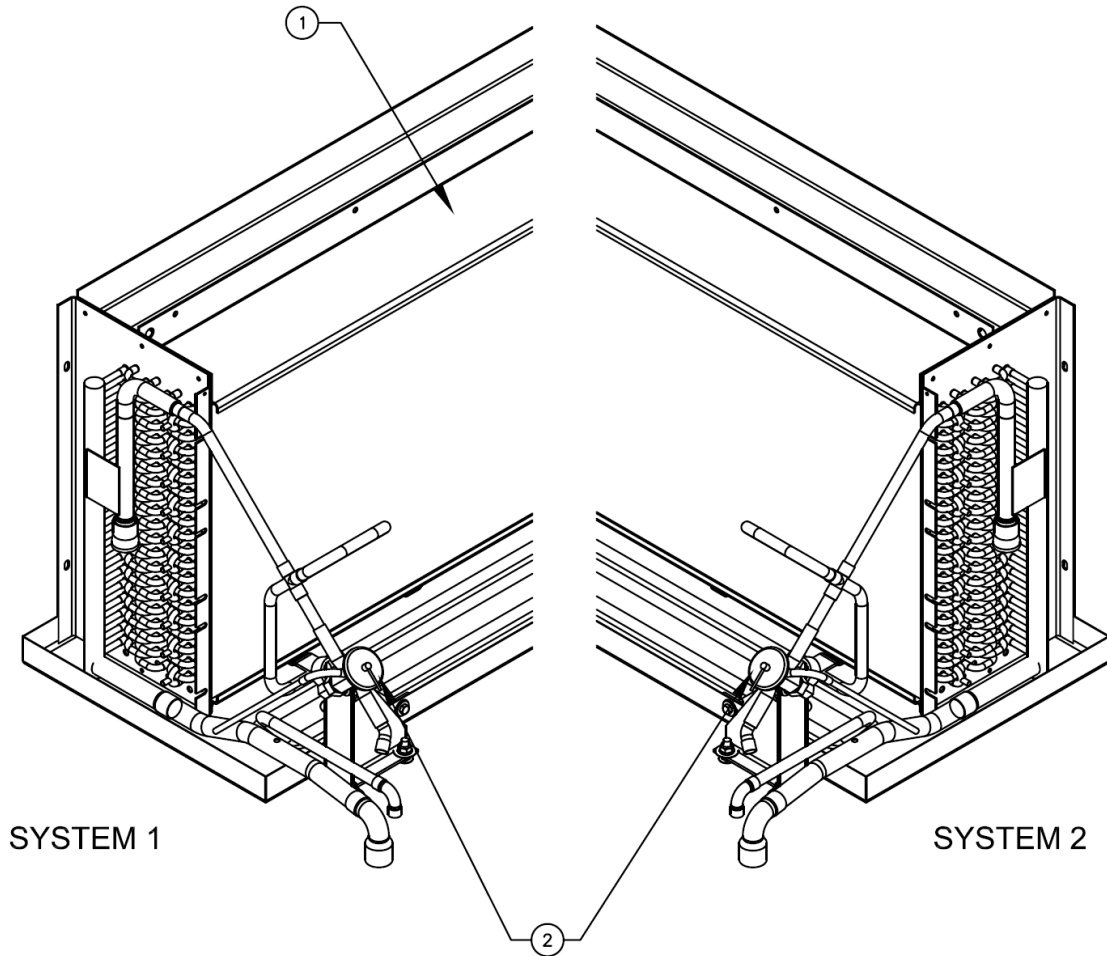

SECTION 7.9C
EVAPORATOR PIPING

7.9C EVAPORATOR PIPING

ITEM	PART NO.	DESCRIPTION	QTY
1	K26-24888-50	COIL EVAPORATOR	1
2	K25-26982-00	VALVE TX 1/2C X 1/8C X 1/4C R-134a	2

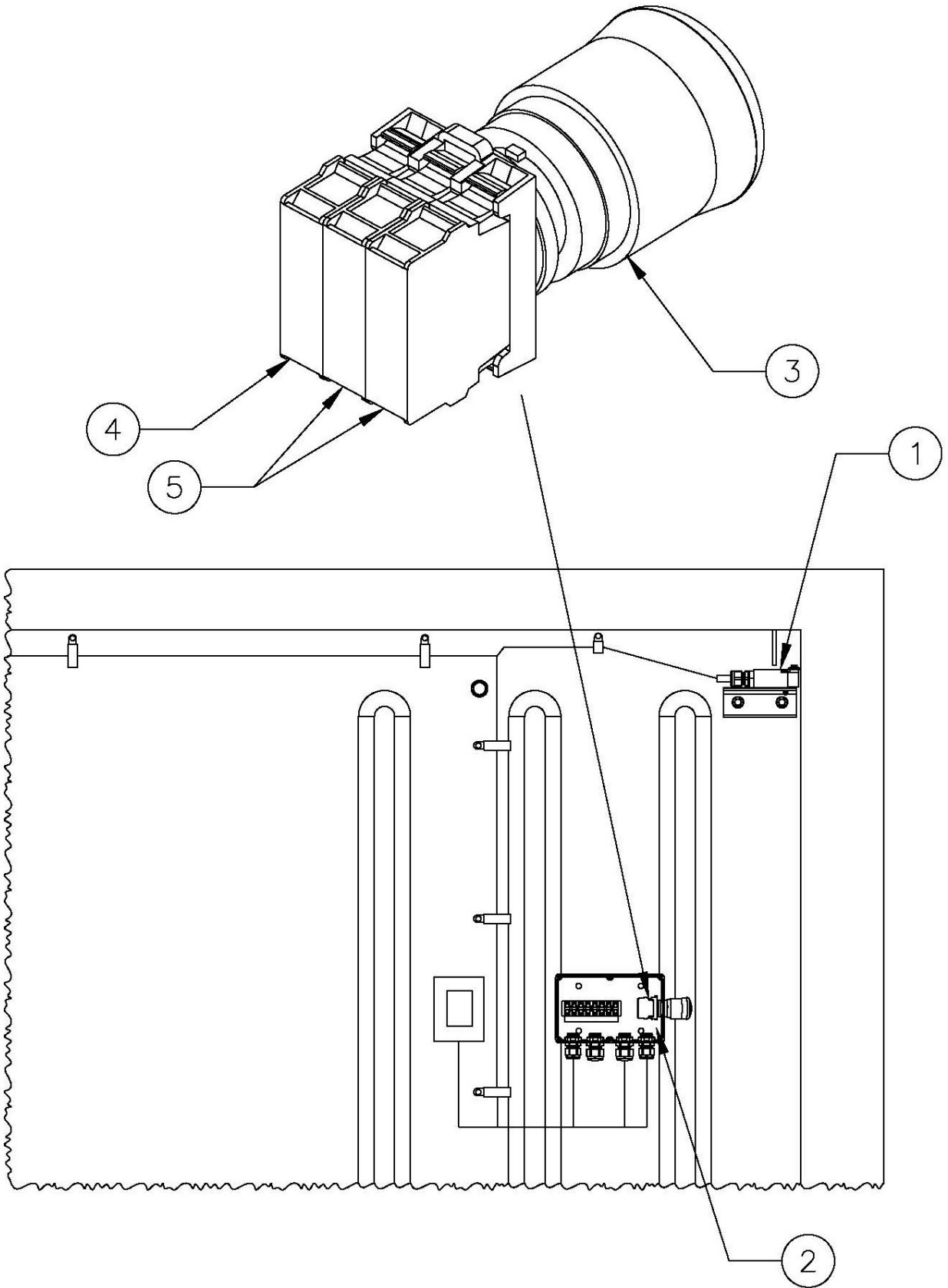

**SECTION 7.10
CONTAINER PARTS**

7.10 CONTAINER PARTS

ITEM	PART NO.	DESCRIPTION	QTY
1	360-18342-03	KIT DOOR SWITCH WITH BRACKET	1
2	360-18343-15	BOX JUNCTION CONTAINER WITH PANIC ALARM	1
		(INCLUDES ITEMS #3, #4, AND #5)	
3	K24-22535-00	SWITCH PB RED PUSH-PULL M22-PV	1
4	K24-22535-02	CONTACT BLOCK NO FOR M22 PB	1
5	K24-22535-01	CONTACT BLOCK NC FOR M22 PB	2

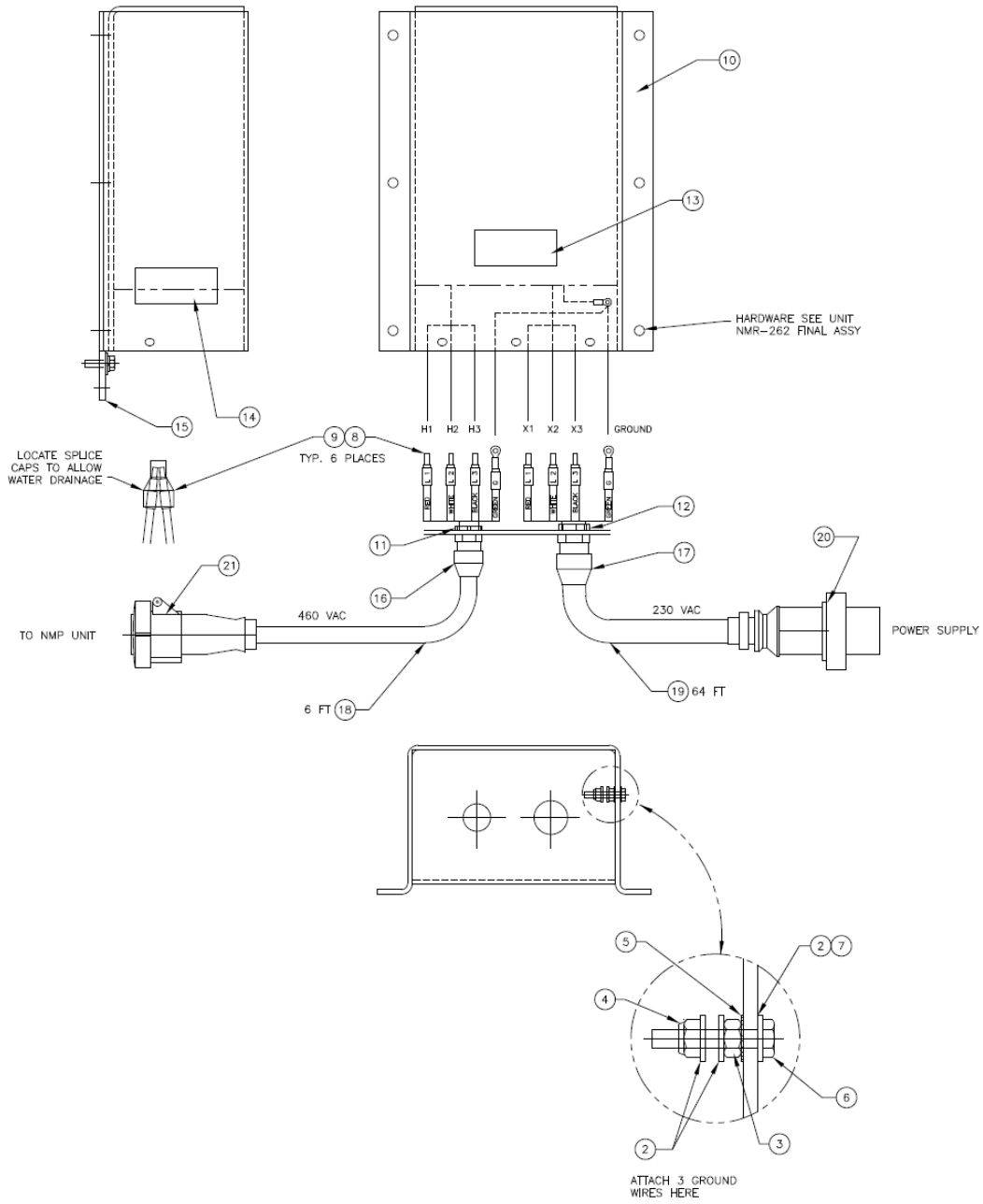

SECTION 7.11
 OPTIONAL
 DUAL VOLTAGE STEP-UP TRANSFORMER
 230 VAC INPUT – 460 VAC OUTPUT

7.11 OPTIONAL DUAL VOLTAGE TRANSFORMER

ITEM	PART NO.	DESCRIPTION	QTY
1	360-11844-00	TRANSFORMER DUAL VOLTAGE	1
		(INCLUDES ALL THE ITEMS BELOW)	
2	K21-10189-00	WASHER FLAT SS ¼ .28 ID .63 OD	3
3	K21-14065-00	NUT HEX SS 1/4-20	1
4	K21-14921-05	NUT LOCK SS1/4-20	1
5	K21-15797-06	WASHER LOCK EXT INT SS 1/4	1
6	K21-16415-02	SCR HEX S 1/4-20 X 1-1/2 FULL	1
7	K21-50492-03	WASHER INSULATED PVC 1/4	1
8	K25-10434-00	TERM SPLICE FERRULE LG COPPER	6
9	K25-10435-00	TERM SPLICE CAP INSULATED LG WHITE	6
10	K25-26092-00	TRANS 15 KVA 230V PRI/480V SEC	1
11	K25-26340-03	NUT LOCK CONDUIT BLACK NYLON 3/4 NPT	1
12	K25-26340-04	NUT LOCK CONDUIT BLACK NYLON 1" NPT	1
13	K35-05683-00	LABEL DANGER HIGH VOLTAGE 3.5 X 5	1
14	K35-05761-00	LABEL TRANSFORMER	1
15	060-10976-00	SUPPORT TRANSFORMER DUAL WHITE	1
16	360-10883-00	CABLE POWER TRANSFORMER TO CONTAINER	1
		(INCLUDES ITEMS 18 & 21) 480 VAC 6 FT	
17	360-11845-00	CABLE POWER 230 VAC 64 FT LG	1
		(INCLUDES ITEMS 19 & 20)	
18	060-11114-05	CORD ELECTRIC SO 10/4 6 FT LG	1
19	060-11113-02	CORD ELECTRIC SO 8/4 64 FT LG	1
20	K25-26101-00	PLUG POWER 60A 250 VAC	1
21	K25-23732-00	RECEPTACLE POWER 32A 380/440V 3P + G	1

7.12 SPARE PARTS KIT

Klinge Corporation recommends keeping a supply of certain parts on hand for immediate replacement in the event of component failure.

The spare parts kit is commonly mounted on the top of the generator set as shown in the below photograph.



In cases where the refrigeration unit is supplied without a generator set, the spare parts kit is mounted to the face of the container, as seen below.

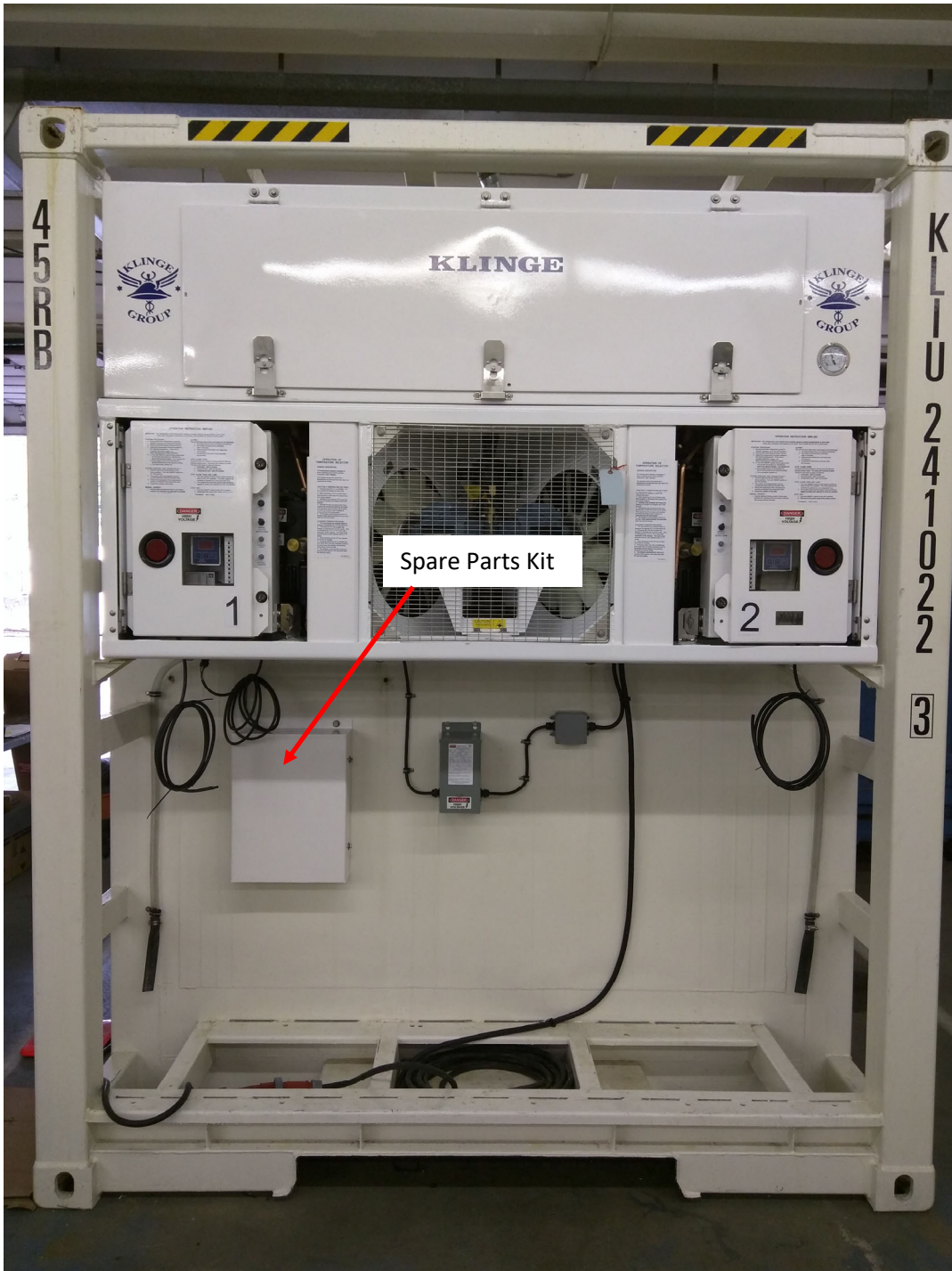

Suggested Spare Parts

DESCRIPTION	Qty	PART NO.
Socket Thermostat	1	360-10829-00
Transformer 230 VA 400 V	1	K25 26624 10
Ribbon Cable 10"	1	360-12540-03
Kit Probe Universal 6"	1	360-13807-00
Kit Probe Universal Temps	1	360-14318-00
Battery Charger	1	360-15580-01
Current Sensing Transformer	1	360-16398-00
Coil Solenoid	1	360-17300-04
Coil Solenoid	1	360-17300-05
Coil Solenoid	1	360-17300-03
Valve Relief	1	K22-07028-02
Valve Pressure Relief	1	K22-07028-03
Boot, SW1	2	K24-17239-00
Boot, Circuit Breaker	2	K24-18164-00
Circuit Breaker, 8A	1	K24-20565-00
SW Tgl SPDT On	1	K24-21355-00
Relay (Engine part)	1	K24-22121-00
Switch, On-Off	1	K24-22144-00
Contactactor, Reversing	1	K24-22148-00
Start 9A 3P 24VAC 50/60 HZ	1	K24 22223 00
Relay (DPDT)	1	K24-22264-01
Ckt Breaker 4Amp	1	K24-22330-00
Circuit Breaker, 25A	1	K24-22363-25
Starter 25A 3P 24VAC	1	K24 22437 01
Switch, High Pressure	1	K25-20869-00
Boot Main Circuit Breaker (Engine part)	1	K28-10785-01
Touch Pad	1	K31-00811-00
Thermostat	1	K31-00967-00
Switch, Oil Pressure 14 PSI (Engine Isuzu)	1	XB-998208
Control Temp Thermostat	1	K25-19557-00

SECTION EIGHT - TEMPERATURE RECORDER

8.1 INTRODUCTION

This manual is a guideline for the installation and use of the **Euroscan TX3** temperature recorders. To avoid guarantee exclusion, it is essential to follow the instructions and recommendations of this manual.

Euroscan recorders are developed and produced to conform to the applicable European and National norms, for the delivery of chilled and frozen foods in transport vehicles.

The temperature recorder can provide evidence of correct temperatures for every trip in the form of a delivery ticket; numerical or graphical print out. All data is stored with a date / time stamp in a large memory. Data will not be lost if power is lost. The real-time clock is powered by an internal back-up battery.

This recorder will record the cargo temperature and has adjustable high and low temperature limits that the customer can set. The temperature limit control is inside the recorder. On the Klinge electrical schematic this signal comes out of Euroscan com 1 and controls a double pole relay TR on Klinge systems, the relay coil is shown on the system 2 schematic (See the electrical schematic for the NMP-282 system 2, located on the system 2 door and in this manual pages) and is the (external temperature relay). If the temperature is within the adjustable limits of the external recorder (Euroscan) the relay contacts will be closed, but if there is a problem they will be open.

On the TR relay one set of contacts is used for each system and the signal goes to terminal 31 at the thermostat (see the electrical schematic in this manual). If the temperature is outside the limits set in the recorder, the relay contact will be open. This will cause a timer in the thermostat to begin (the temp fail LED on the thermostat will come on), after 1 hour the unit alarms will activate and the horn and large lamp will flash. The system on primary will now become secondary and the secondary will now be primary. The alarms in the failed system will continue (the LED that caused the alarm will also be on - this should be noted before the unit is turned OFF) until the system is turned OFF and then ON (reset).

Turning the NMP-282 system that shows an alarm OFF will turn off and reset all the alarms in this system.

8.2 DATA SECURITY

Although the Ameriscan recorder has been specifically designed and tested for use in the harsh vehicle environment, there are certain circumstances beyond our control. For example, lightning strikes, theft, manipulation, etc., could cause data loss. Because the temperature data might be crucial to providing evidence in the case of food losses, we strongly advise you to take the following precautions:

- Print or download data to a PC on a weekly basis as back up.
- For a long-term storage of data, we recommend to down-load the data using the supplied cable 360-12360-02 & free computer software, obtained by contacting inquiry@klingecorp.com. OPTIONAL data logging software K31-009003-12 and infrared scanner K31-00903-13
- Check the correct functioning of recorder frequently
- Check recording system every 12 months to see if the measurement is within the legal error limit.
- Do not weld without disconnecting the power from the recorder or vehicle.
- Do not take the power supply from a generator system without extra filter protection against high voltage peaks. Preferably always take power from the vehicle or fridge battery.
- Follow the installation and user instructions in this manual.



Installation & Operation Manual X3

Document Number: PRO.020

Revision: 1.0

© 2015 Euroscan —All Rights Reserved.

This publication, or any part thereof, may not be reproduced or transmitted in any form or by any means, electronic or mechanical, including photocopying, recording, storage in an information retrieval system, or otherwise, without prior written permission by Euroscan.

Trademark Notice

The Euroscan Company logo is a trademark of Euroscan B.V. All other product names used throughout this material are trademarks of the respective companies. No such use of any trademark is intended to convey endorsement or other affiliation with these companies.

Disclaimers

This document is the proprietary and exclusive property of Euroscan except as otherwise indicated. No part of this document, in whole or in part, may be reproduced, stored, transmitted, or used for design purposes without the prior written permission of Euroscan.

This document contains technical information and descriptions of the ORBCOMM System that reflect the status of the system design and/or planned design as of the date of issue. The contents of this document are subject to change without notice, and no warranty or representation, expressed or implied, is made with respect to its contents.

Table of Contents

About this Installation Manual

- Disclaimer
- Purpose
- Revision History
- Regulations
- Document convention
- Terminology
- Intended use statement
- Safety Guidelines
- WEEE Statement
- Customer Care

Configuration

Operating this Unit

- LCD Display
- Keyboard
- Printer
- Bluetooth
- Low power mode

User menu Euroscan TX3 / RX3

- (Menu - 1) Print menu
- (Menu - 2) Alarm settings
- (Menu - 3) User settings menu
- (Menu - 4) Status menu
- (Menu - 5) Temperature input settings
- (Menu - 6) Digital inputs
- (Menu - 7) compartment settings
- (Menu - 8) Alarm settings
- (Menu - 9) Printer settings
- (Menu - 10) General settings
- (Menu - 11) Communication settings

Maintenance

- Inspection
- Error codes
- RMA
- Replace paper roll
- Euroscan TX3 / RX3 recorder calibration
- Euroscan TX3 / RX3 recorder temperature verification

Technical specifications

Factory settings

About this Installation Manual

Thank you for purchasing this Euroscan TX3 / RX3 recorder. Please read these instructions carefully and keep them in a safe place. Always follow all safety instructions. All statements, technical information and recommendations related to Euroscan products are based on information believed to be reliable, but the accuracy or completeness is not guaranteed.

Both products (RX3 and TX3) are produced by Euroscan in the EU. Euroscan has a policy of continuous development and improvements. Therefore, *products, manuals and technical information are subject to change without prior notice.*

Disclaimer



Important:

This manual contains information about Euroscan TX3 / RX3 recorders. No representations or warranties are made as to the accuracy or completeness of the information contained herein. No representation or warranties are made as to the completeness and compliance of any installations, which are performed using this manual.

Purpose

This manual contains detailed installation information for and operation of the Euroscan TX3 / RX3 recorders. Please follow the instructions and recommendations of this manual for a proper installation. Improper installations will void the product warranty. The intended audiences for this manual include field support personnel, product evaluators and certified third-party personnel. It is particularly intended for personnel who are responsible for system installation and activation. In addition, and is appropriate, this manual may be used for customer training purposes.



Fig. 1 RX3

Regulations





Only Euroscan trained and qualified personnel should be allowed to install, replace or service the recorder. The Euroscan certified installer needs to perform the installation of the recorder complying with at least the following:

- This installation and operation manual and other relevant documentation provided by the manufacturer.
- EMC Directive 2004/108/EC.
- Low Voltage Directive 2006/95/EC.
- Harmonized standards under Directive 1999/5/EC.
- WEEE Directive 2012/19/EU.
- Traffic regulations of the country of installation and countries in which the recorder will be used.

- Regulations and instructions described in the installation and operation manual of any supplementary device(s).

Document conventions

Below are some 'common ground' conventions which are used in this document;

	Will be used when referring to exact recorder menu items or options
	Will be used to indicate buttons, such as <Print> button.
	Caution Will be used to indicate an explicit message possibly resulting in injuries, unexpected behavior or damaged hardware
	Operator alert Will be used to indicate a message which needs special attention

Terminology

Below are some terms and expressions commonly used by Euroscan.

Recorder	The X3 recorder. It is the device intended to be used to make measurements, alone or in conjunction with supplementary device(s).
Temperature sensor	Element of a measuring instrument or measuring chain that is directly affected by the temperature
Refrigerator	A refrigerator connected to the recorder. Also referred to as reefer or fridge.
Keyboard	The keyboard is the panel on the front of the recorder with the colored buttons.
Protection guard	Cage to protect temperature sensors
Mapping	Reading sensor from external source and processing as own sensor information
OC	Open circuit
SC	Short circuit

Intended use statement

The recorder is designed to safely operate under the following conditions:

- Operating voltage: 10-32 VDC (negative earth), protected against alternator load shedding.
- Temperature in operation : -30 °C / +70 °C (-22 °F / 158 °F)
- Temperature maximum : -40 °C / +85 °C (-40 °F / 185 °F);
- Humidity: 97% relative humidity at 25 °C (77 °F).
- No special ventilation requirements. Euroscan recorders are designed for use in an automotive environment.
- For protection a 10A floating fuse must be fitted in the positive (+VE) power line as close as possible to the power connection (provided in installation kit).

Use of this product in adverse conditions will void the product warranty.

Safety Guidelines

- Be aware of hazards involved with electrical circuitry and be familiar with standard practices for preventing accidents.
- Do not modify the recorder in any way.
- Do not work on the system or connect or disconnect cables during periods of lightning activity.
- Do not expose the Euroscan RX3 recorder to rain or moisture
- Do not expose the Euroscan TX3 recorder (the inside) to rain or moisture during installation
- Do not install near heat sources such as exhaust pipes.
- Only use accessories specified by the manufacturer.
- Do not use the recorder if it has been physically damaged or shows to be abused.
- A lithium battery is used in the recorder. Do not try to charge, discharge or replace this battery.
- Do not work on the installation when the recorder is connected to a power supply, except when connecting the antenna(s) (see ESD warning for the Euroscan RX3 installation instruction).

WEEE Statement

Ultimate disposal of this product should be handled according to all national laws and regulations.

<p>The mark shown to the right is in compliance with Waste Electrical and Electronic Equipment Directive 2002/96/EC (WEEE). The mark indicates the requirement NOT to dispose the equipment as unsorted municipal waste, but use the return and collection systems according to local law.</p>	
--	--

Customer Care

Review entire installation manual before proceeding.

Please contact Customer Care at +49 (0) 228-926380 should there be any questions during the replacement.

Configuration

After finishing the physical installation of the temperature recorder it should now be configured. All parameters are stored in a parameter file. After every standard installation a number of parameters need to be either checked or changed.

Language

- Press the <green button>
- Select menu 3.5 [Select language] and press the <green button>
- Select the desired language and confirm with the <green button>
- Press the <red button> to return to the normal display.

Timezone

- Press the <green button>
- Select menu 3.1 [Time zone offset] and press the <green button>
- Select the desired time zone offset and confirm with the <green button>
- Press the <red button> to return to the normal display.

Daylight saving time

Please find out if daylight saving time applies for the recorder and adjust accordingly:

- Press the <green button>
- Select menu 3.4 [DST correction] and press the <green button>
- Select the desired daylight saving time setting and confirm with the <green button>
- Press the <red button> to return to the normal display.

Vehicle ID

The vehicle ID will appear on printed tickets:

- Press and hold the <green button> for 4 seconds to get into the parameter mode.
- Enter the PIN code 1111 by pressing the <blue button> 4 times.
- Select menu 10.5 [Vehicle ID] and press the <green button>.
- Now enter the vehicle ID.
- Press the <green button> and the <red button> simultaneously to accept.
- Press the <red button> 2 times to return to the normal display

Header text

The header text will appear on printed tickets and is usually used for defining the customer's name.

- Press and hold the <green button> for 4 seconds to get into the parameter mode.
- Enter the PIN code 1111 by pressing the <blue button> 4 times.
- Select menu 10.6 [Header text] and press the <green button>.
- Now enter the customer's name.
- Press the <green button> and the <red button> simultaneously to accept.
- Press the <red button> 2 times to return to the normal display

Alarm signal

The internal alarm signal (persistent buzzer) can be heard as soon as a defined temperature threshold has been exceeded. In case of an alarm an external signal is also activated if this is installed. Furthermore the corresponding temperature input will flash on the display. The internal signal buzzer can be switched off by pressing the yellow (alarm) key. The external signal and the flashing display will only stop after the temperature is back within the defined limits.

Operating this Unit

Euroscan TX3 / RX3 recorders are developed and produced conform to the applicable European and National guidelines, for the delivery of chilled and frozen transport goods in transport vehicles (EN12830).

Euroscan TX3 / RX3 recorders can provide evidence of correct temperatures for every trip in the form of a delivery ticket, numerical or graphical print-out. All data is stored with a date/time stamp in a large flash memory. Data will not be lost if power supply is disconnected. The real time clock is powered by an internal back-up battery.

Although the Euroscan TX3 / RX3 recorders have been specifically designed and tested for use in a harsh vehicle environment there are certain circumstances beyond our control, i.e. lightning strikes, high voltage peaks, theft, manipulation, etc., where data loss could occur. Because the temperature data might be crucial to providing evidence in the case of transport damages, we strongly advise you to take the following precautions:

- Print or download data to a PC on a **weekly** basis as a back up.
- For a long-term storage of the data, we recommend to **download** the data via EuroTool. In addition to the BlueTooth connection, Euroscan offers the communication options for automated data transfer by use of a GPRS modem... For further information please contact the Euroscan sales team or visit our website at www.euroscansupport.com.
- Check the correct functioning of the recorder frequently (minimum – together with the refrigerator service).
- Check the recording system every 12 months to see if the temperature measurement error is within the maximum permissible error. The annual test is obligatory, according to resp. EN 12830 or EN 13486.
- Do not weld without disconnecting the power from the Euroscan TX3 / RX3 recorder or the vehicle.
- Do not take the power supply from a generator system without extra filter protection against high voltage peaks. Preferably, always take power direct from the vehicle or refrigerator battery.
- Follow the installation and user instructions in this manual.

LCD Display

The display has four lines of information, showing the following content in the operating mode.

- Line 1 : Alarm activated; temperatures; status of digital inputs
- Line 2 : Rotating display of each active temperature with sensor name
- Line 3 : Day, date and time with indication of summer/wintertime
- Line 4 : Description of the actual button functions

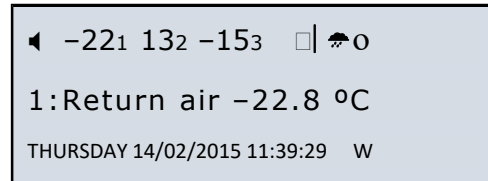

In every other mode the content of the display is dependent on the actual menu in use.

Keyboard

Euroscan RX3 / TX3 is completely menu controlled. All functions can be operated by the four colored buttons (like printing, activate alarms or change parameters). The actual functions of the buttons are always displayed on the bottom line. To navigate through the menus and change settings, two different kinds of button functions are applicable. You can navigate through the menus by selecting a parameter from a table in the **edit mode**,

Use the buttons as described below:

	Blue	↑	Previous item of the menu
		<	In edit mode: previous item from the list
	Yellow	↓	Next item of the menu
		>	In edit mode: next item from the list
	Green	edit	Menu select, change to edit mode or one menu level down
		accept	In edit mode: accept input and go to next menu point
Red	<-Menu	One menu level up	
	<-Cncl	In edit mode: cancel input and display the non-changed value. Press 4 seconds for rejecting input and go back to previous menu.	

When entering free programmable text, such as names, the button functions are as follows:

	Blue	↑	Next character from the list
	Yellow	↓	Previous character from the list
	Green	<	One character to the left
	Red	>	One character to the right
	Blue + Yellow	<-Cncl	Cancel input and display the non-changed value. Press for 4 seconds to reject the input and go back to the previous menu.
	Green + Red	accept	Accept input and go to next menu point.

Printer

The thermal printer is installed on the right side of the recorder. For more details about replacing the paper roll, please refer to chapter 0 4.4 Replace paper roll.

Bluetooth

The Euroscan TX3 / RX3 recorder has a built-in Bluetooth module. With this communication option EuroTool can connect wireless to the recorder over Bluetooth.

In order to use the Bluetooth feature, please check the following requirements:

- A computer/laptop with Windows XP or newer
- A Bluetooth dongle
- Eurotool 7.2.3 or higher

The following Bluetooth installation instructions will show you how to install and connect.



Before plugging the Bluetooth dongle into your PC/laptop, make sure all old Bluetooth drivers are removed from your system and reboot your system.



Make sure you are within a few meters of the recorder when connecting.

Step 1) Plug the dongle into a USB port.

Step 2) Wait for Windows to install the drivers.

Step 3) After Windows successfully installed the drivers, a Bluetooth icon should appear in your taskbar notification area.



Step 4) Right click on the Bluetooth icon and select "Open Settings".

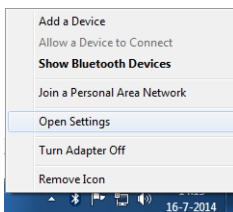

Step 5) Make sure your checkboxes are checked like in the picture below (Uncheck the "Alert me when a new Bluetooth device wants to connect" box):

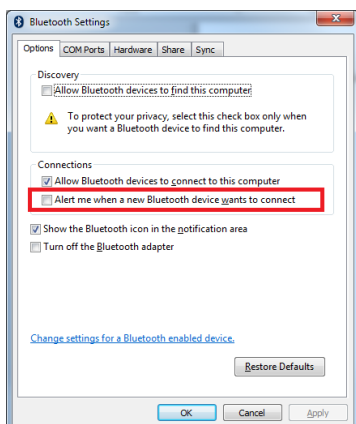

Step 6) Start **Eurotool 7.2.3** or higher. Go to the “Settings” tab and select “Bluetooth” in the “Comport” selection box.

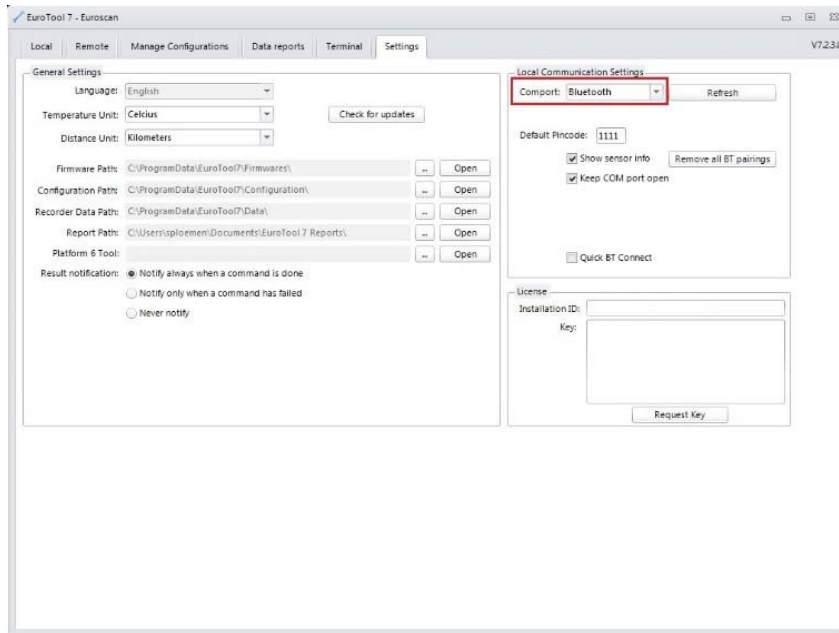

Step 7) Go to the “Local” tab. Wait for the dongle to detect recorders. This may take a few minutes.

Step 8) Select the recorder and click on “Connect”. Wait for EuroTool to establish the connection.
If the wanted recorder is not listed, click on “Scan” to rescan. This will take about 10 seconds.

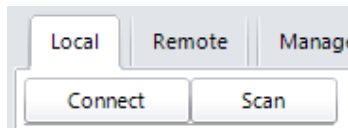

Step 9) EuroTool is connected to the recorder when a similar screen is displayed.

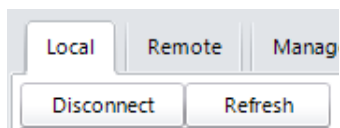

Low power mode

The Euroscan TX3 / RX3 recorder is capable of reducing power usage. In this mode all peripheral components and all communication are switched off. The recorder will only do measurement, power management and store measured temperatures. Low power mode can be initiated by inactivity or when the battery voltage drops below a set limit for a specified time.



During low power mode there is no communication with the server or any other serial unit possible.

During low power mode it is possible to a wake up interval and time, which can be used the re-establish communication with the server.

User menu Euroscan TX3 / RX3

The recorder has four different user menus which are accessible via the keyboard without PIN code:

- **Print menu**
- **Alarm menu**
- **User settings menu**
- **Status menu**

(Menu - 1) Print menu

Press the <blue button>. The last selected print choice will be displayed. Printing now starts after 4 seconds. Repeatedly pressing the <blue button> will scroll between the available print options: delivery ticket, journey ticket graphical, journey ticket numerical and historical ticket.

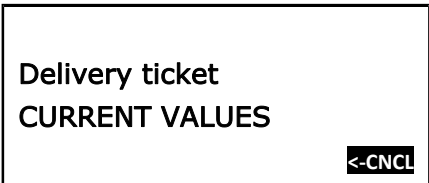

By holding the <blue button> for more than 4 seconds the following sub-menus can be reached:

(M - 1.1) Select compartment to print

By pressing the <green button> you confirm that you wish to change the settings. The chosen compartment can be selected by pressing

< **>** and your choice can be confirmed with **ACCEPT**

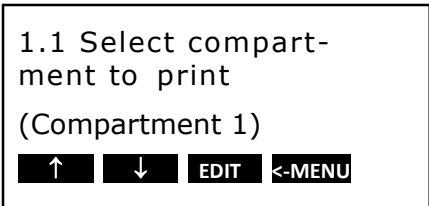

(M - 1.2) Time zone offset for printing

This option is intended to change the time-zone of your printout.

1.2 Time zone offset
for printing
(UTC+ 1:00 hour(s))

↑ ↓ EDIT <-MENU

(M - 1.3) Print report EVENTS

By pressing the <green button/ **PRINT**>, printing of the event report will start.

1.3 Print report
EVENTS

↑ ↓ PRINT <-MENU

(M - 1.4) Print report PARAMETER

By pressing the <green button/ **PRINT**>, the parameter report will be printed after entering the correct pin code (1-2-1-2).

1.4 Print report
PARAMETERS

↑ ↓ PRINT <-MENU

(M - 1.5) Historical

By pressing the <green button/ **EDIT**> you can select a historical date for printing. Pressing the <green button/ **ACCEPT**> again lets you select the time period of your historical report.

Pressing the <green button/ **ACCEPT**> for the 3rd time lets you choose what report you want to have printed. You can change the report by pressing the <blue> or <yellow button>. Printing starts after a delay of 4 seconds.

1.5 Historical
(dd/mm/yyyy)

↑ ↓ EDIT <-MENU

(M - 1.6) Delivery ticket setting

With **EDIT** you can set the desired information printed on the delivery ticket. You can select "Actual only", "Actual + average" or "Actual+avg. +min/max". By pressing the <green button> you **ACCEPT** your choice.

1.6 Delivery ticket
setting
(Actual+average)

↑ ↓ ACCEPT <-MENU

(M - 1.7) Print time period

With this option you define the total print period.

1.7 Print time period
(10 hour(s))

↑ ↓ EDIT <-MENU

(M - 1.8) Day start time

This option defines the time which is taken as start time for the printout (printouts are printed backwards until this time).

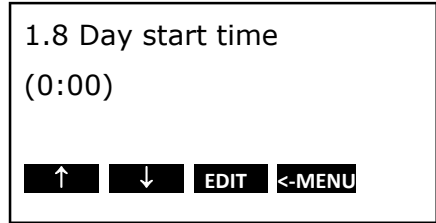

(M - 1.9) Day end time

This option defines the time from which the printout is printed backwards (please note that a printout is always printed backwards, i.e. from the day end time till start time).

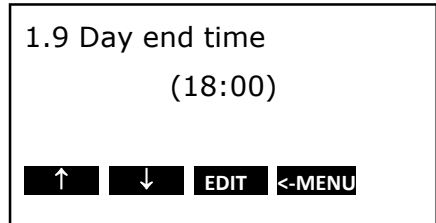

Examples:

- You want to make a printout for a certain date in the past for a time period which exceeds the day start time. **Please change day start time to 0:00 h and enter the desired time period.**
- You want to make a printout for 2 days. **Change time period to 2 days, day start time to 0:00 h - day end time to 0:00 h.**

(M - 1.10) Journey marker

The journey marker can be used to set the start point of a journey ticket. To define a starting point for a dedicated journey, please hold the <yellow button> for more than 4 seconds. The display will indicate the status as shown in the picture on the right.



The printed ticket will never be longer than the print time period as defined in **(M - 1.7) Print time period.**

Example: The journey marker is set on 13:00h and the print time period is set to 2 hours. If a ticket is printed on 14:00h, the start time will be 13:00h. If a ticket is printed at 15:30h, the start time will be 13:30h.

(Menu - 2) Alarm settings





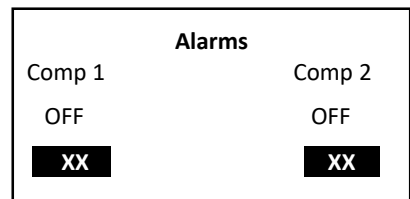

Up to four different alarm types can be assigned to four different compartments. The various alarms (and compartments) are only available if the supervisor has preset and configured them in the parameter menu.

Press the <yellow button> to access the alarm menu where you have direct access to compartment 1 + 2.



(M - 2.1) compartment 1

By pressing the <yellow button> two times you enter the options where compartment settings can be changed.

With   you toggle between the compartments which are available. The value given in brackets shows the actual setting. By pressing  you can change alarms for the selected compartment. With   you select the desired alarm type (including alarm off). By pressing  the new setting will be activated.

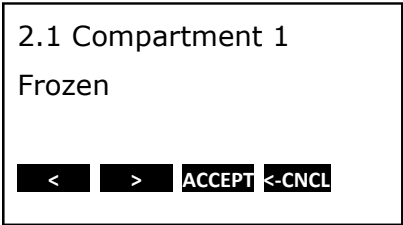

2.1 Compartment 1
Frozen

(M - 2.2) compartment 2

(The same as compartment 1)

(M - 2.3) compartment 3

(The same as compartment 1)

(M - 2.4) compartment 4

(The same as compartment 1)

(M - 2.5) Digital input 1

The Euroscan TX3 / RX3 recorders are provided with 4 digital inputs. These inputs can be used for invoking alarms from door switches and refrigerator's. The alarm condition is reached if an input remains in an alarm condition for a certain period of time. This preset (delay time) can be setup to 60 minutes.

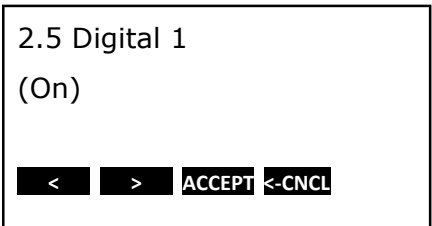

2.5 Digital 1
(On)

(M - 2.6) Digital input 2

(The same as Digital input 1)

(M - 2.7) Digital input 3

(The same as Digital input 1)

(M - 2.8) Digital input 4



(The same as Digital input 1)

(M - 2.9) Alarm output test





By pressing the <green button/  > you will initiate the external alarm for 10 seconds. This is the A0-output on the back of the recorder. You could connect this to a light or buzzer for extra signaling.

(Menu - 3) User settings menu

Within the user settings menu, several adjustments can be made to offer the user a maximum of user convenience. By pressing the <green button> the user setting menu will be activated.

Toggle with   between the available menu options. The actual setting is displayed between the brackets (..). With the <green button/> **EDIT** you enter the edit mode.

(M - 3.1) Time zone offset

Select hours, minutes, and seconds with   and adjust with  . Confirm the setting with **ACCEPT** (green-red).

3.1 Time zone offset
(UTC+ 1:00 hour(s))

  **EDIT** 



(M - 3.4) DST correction

Here you can choose to have the recorder adjust the time according to day light saving in the selected time zone.

3.4 DST correction
(On)

  **EDIT** 



(M - 3.5) Select language

Select the desired language with   and confirm with **ACCEPT**.

3.5 Select language
(English)

  **ACCEPT** 



(M - 3.6) Set display contrast

Set the desired display contrast with   and confirm with **ACCEPT**. If you set this value to low, you might not see anything on the display

3.6 Set display
contrast

  **ACCEPT** 

(M - 3.7) Set display backlight

Set the intensity of the backlight to your convenience with   and confirm with **ACCEPT**. This applies to the display backlight that switches on when you press any button. When pressing no button, the backlight automatically switches off after 30 seconds.

3.7 Set display
backlight

  **ACCEPT** 

(M - 3.8) Set buzzer volume

Change the buzzer volume with **<** **>** and confirm with **ACCEPT**. This only applies to the sound of the keys being pressed, and not to alarms.

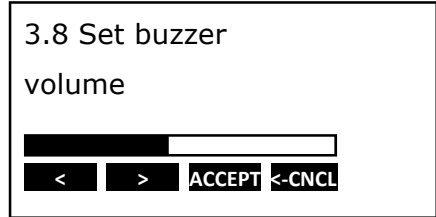

(M - 3.9) Set buzzer frequency

Change the buzzer frequency with **<** **>** and confirm with **ACCEPT**. This only applies to the sound of the keys being pressed, and not to alarms.

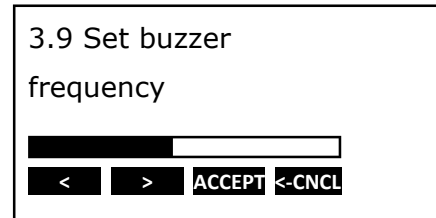

(M - 3.10) Set buzzer on-time

Change the buzzer on-time with **<** **>** and confirm with **ACCEPT**. This only applies to the sound of the keys being pressed, and not to alarms.

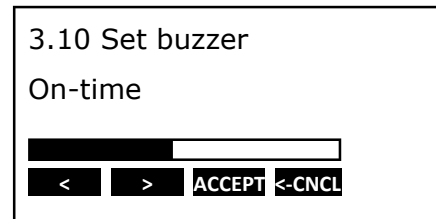

(M - 3.11) TMS X3 Vx.xx.x

Displays the current firmware version of the recorder

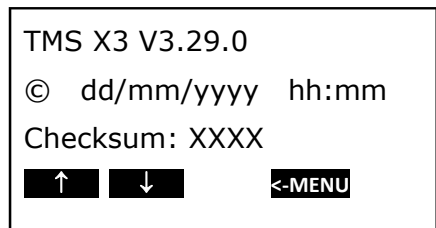

(Menu - 4) Status menu

Pressing the <red button> will change the display mode between full menu information and only showing actual temperatures. These values enlarged with readings to one decimal point. In order to return to the main display please press any other button.

T1	11.2	T2	20.0
T3	-12.3	T4	-3.8
T5	-18.7	T6	OC

(M – 4) Parameter menu

The Euroscan TX3 / RX3 recorders have been designed to enable a multiple number of desired applications for individual customers. By using the corresponding parameter settings you can adjust the recorder functionality to the required needs. This chapter gives an overview and structure of the various parameters available.

To enter the parameter menu press the <green button> for 4 seconds. The display will show: “ENTER PINCODE”. The default setting of the pin code is **1111**, but can be adjusted by the supervisor at any time (ask your distributor).

After entering the correct pin code you have access to the parameter menu and the first menu level is displayed. Select the desired item with [↑], [↓] and press [EDIT] to enter one of the following options:

- 5 *Temperature inputs settings*
- 6 *Digital inputs settings*
- 7 *compartment settings*
- 8 *Alarm settings*
- 9 *Printer settings*
- 10 *General settings*
- 11 *Communication settings*

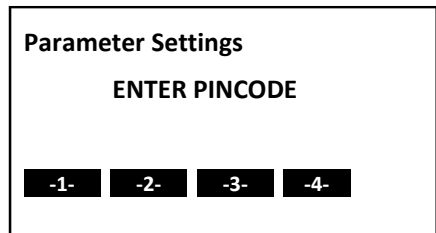

A 4 digit PIN code has to be entered in order to enter menus 5 to 11.

(Menu - 5) Temperature input settings

The inputs for temperature measurements can be switched on/off and assigned a name. Depending on the sensor position the default input 1 is preset as 'Return air' and input 2 as 'Rear'.

(M-5.1) T1 input

If set to „on“ input 1 will be measured, displayed and stored into memory. Printing of input 1 is assigned in the compartment setting (menu item 7). When set to 'Off', the following points will not be an option in the menu

(M-5.1.1) Type

There are several types of sensors that you can select here that will function as your data input. Please make sure you are using the correct type for the connected or mapped information.

Physically connected sensors on the X3

Temp. 110	(-10 to +110 Degrees Celsius)	
Temp. 500	(-5 to +500 Degrees Celsius)	
Temp. Standard	(-50 to +70 Degrees Celsius)	(Default)
Relative Humidity	(0..1 V)	
Universal	(0..2,5 V)	
Current sensor	(4..20 mA)	

Mapped sensors (values that come from external devices)

External sensor
Transcan
DataCold 500
Fridge

(M - 5.1.2) Mapping

This gives the option to read the information from external connected devices to be placed on this input. This only applies for the last 4 input types (External sensor, Transcan, Datacold 500, Fridge) You select what input (1..9) you want to read from what com-port (Com1 & Com2) with **<** **>** and confirm with **ACCEPT**. We recommend using EuroTool 7 for easier setup!!

5.1.2 Mapping

COM1: External 1

< **>** **ACCEPT** **<-CNCL**

(M - 5.1.3) Logging

This allows for storing the input values in a different way. (**Default = average**). Using any of the other options (min./max./avg./off) might lead to totally different temperature reading. Please contact your customer care team when you want to adjust these values.

5.1.3 Logging

Avg.

< **>** **ACCEPT** **<-CNCL**

(M - 5.1.4) Alarm

This allows for detecting an alarm situation via a different approach of evaluating the input values. (**Default = average**). Using any of the other options (min./max./avg./actuals) might lead to totally different alarm detections. Please contact your customer care team when you want to adjust these values.

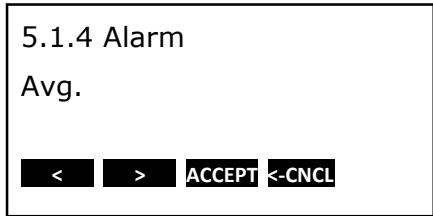

(M - 5.1.7) Function

You can select a general function indicator from the table

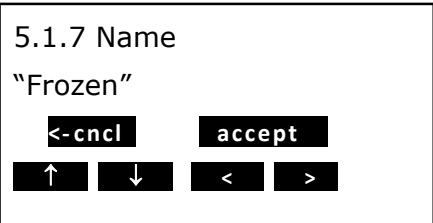

(M - 5.1.8) Name

Enter a name for this input as desired via the four buttons

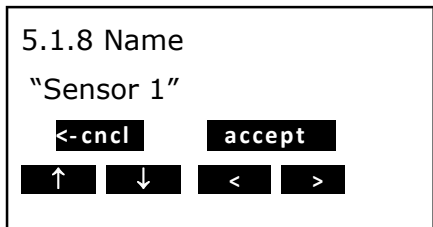

(M - 5.2) T2 input

(The same as T1 input)

(M - 5.3) T3 input

(The same as T1 input)

(M - 5.4) T4 input

(The same as T1 input)

(M - 5.5) T5 input

(The same as T1 input)

(M - 5.6) T6 input

(The same as T1 input)

(Menu - 6) Digital inputs

The 4 digital inputs for status recording can be switched on/off, assigned a name and inverted polarity.

In the operating mode you can see on the display which inputs are activated. The state of the icons is highly dependent on the parameters that you set. Below you find a list of the icons you can see when the digital is active or inactive. Please keep in mind that detecting an active/inactive is dependent on how the sensor is connected on the Digital inputs and how detection takes place (Activation input Menu 6.1.3).

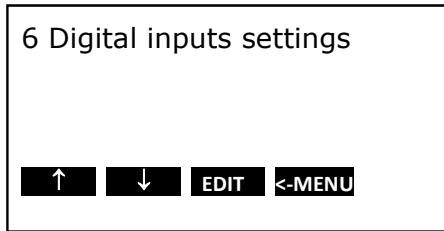

Function	Active	Inactive
Defrost	☂ = Defrost	o = Defrost
Refrigeration	☐ = Refrigeration	o = Refrigeration
Back/Side Door	⌋ = Back door / Side door	= Back door / Side door
Battery backup	☐ = Battery back-up active/low charge – the recorder is working on normal power	■ = Battery back-up active/high charge – the recorder is working on backup battery
compartment On/Off	⏏ = compartment on	✕ = compartment off
	The compartment On/Off function can be used to setup a digital to control the compartment alarmgroup. For instance when enabling this function for digital 3, the alarmgroup of compartment 3 is controlled by the digital status.	

(M - 6.1) Digital input 1

If set to 'on', every input status change on D1 will be displayed and recorded with a date/time stamp.

(M - 6.1.1) Function

You can select a general function (indicator) from the table above.



(M - 6.1.2) Name

Enter a name for this Digital input as desired via the four buttons

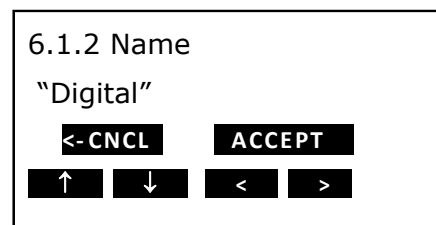

(M - 6.1.3) Activation input

Here input-polarity-switching or mapping is possible.
Switch the function to "high": contact closed = input active.
Switch the function to "low": contact open = input active.
Use the different mapping options if you would like to copy the state of the digital from an external device (External input, Transcan input, DataCold 500, Fridge).

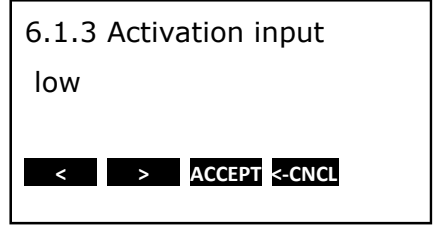

(M - 6.1.4) Mapping

This gives the option to read the information from external connected devices to be placed on this input. This only applies for the last 4 Activation inputs (External sensor, Transcan, Datacold 500, Fridge)
You select what input (1..9) you want to read from what com-port (Com1 & Com2) with [<] [>] and confirm with [ACCEPT].
We recommend using EuroTool 7 for easier setup!

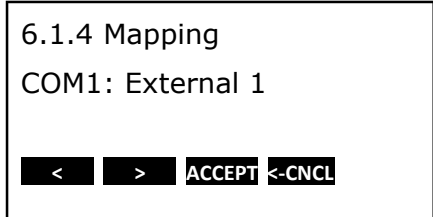

(M - 6.1.5) Alarm

Set to "ON" in order to activate an alarm for this input when this input is active.

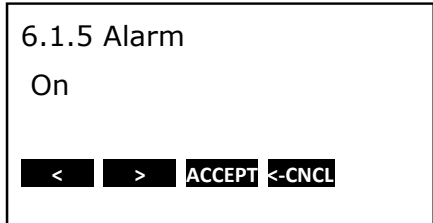

(M - 6.1.6) Alarm Delay time

The delay time given in minutes before the Alarm is activated.

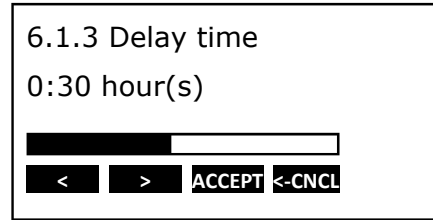

(Menu - 7) Compartment settings

In this menu you can configure the print- and alarm-functions of the inputs for up to 4 compartments. Per compartment an alarm group (Menu 8) can be assigned. The assigned alarm group will then be used to monitor the assigned inputs of the compartment.

(M - 7.1) compartment 1

Here you can activate or deactivate the compartment 1

(M - 7.1.1) compartment name

You can change the compartment name to any value that you like

7.1.1 Compartment name
"Compartment 1"
←- cncl accept
↑ ↓ < >

(M - 7.1.2) Print T1

Choose whether T1 should be printed with this compartment when printing the delivery ticket.

7.1.2 Print T1
On
< > ACCEPT ←-CNCL

(M - 7.1.3) Alarm on T1

Choose whether T1 will be monitored in this compartment when an alarm group is assigned.

7.1.3 Alarm on T1
On
< > ACCEPT ←-CNCL

(M - 7.1.4) Print T2

(Same as Print T1)

(M - 7.1.5) Alarm on T2

(Same as Alarm T1)

(M - 7.1.6) Print T3

(Same as Print T1)

(M - 7.1.7) Alarm on T3

(Same as Alarm T1)

(M - 7.1.8) Print T4

(Same as Print T1)

(M - 7.1.9) Alarm on T4

(Same as Alarm T1)

(M - 7.1.10) Print T5

(Same as Print T1)

(M - 7.1.11) Alarm on T5

(Same as Alarm T1)

(M - 7.1.12) Print T6

(Same as Print T1)

(M - 7.1.13) Alarm on T6

(Same as Alarm T1)

(M - 7.1.14) Print D1

Choose where D1 will be monitored for an alarm state (not dependent on alarm group)

(M - 7.1.15) Print D2

Choose where D2 will be monitored for an alarm state (not dependent on alarm group)

(M - 7.1.16) Print D3

Choose where D3 will be monitored for an alarm state (not dependent on alarm group)

(M - 7.1.17) Print D4

Choose where D4 will be monitored for an alarm state (not dependent on alarm group)

(M - 7.2) compartment 2

(Menu structure as menu 7.1)

(M - 7.3) compartment 3

(Menu structure as menu 7.1)

(M - 7.4) compartment 4

(Menu structure as menu 7.1)

(Menu - 8) Alarm settings

There are 4 alarm groups – each with their own name, upper and lower temperature limit and a delay time. An alarm group can be assigned to a compartment (Menu 7) to monitor the inputs of that compartment. Each enabled alarm group can be used on any and each compartment, although per compartment only one alarm group can be set at the same time.

(M - 8.1) Alarm Group 1

Here you can activate or deactivate an alarm group.

(M - 8.1.1) Function

You can select a general function indicator from the table.

8.1.1 Function

Dry

< > ACCEPT <-CNCL

(M - 8.1.2) Name

You can change the alarm group name to any value that you like.

8.1.2 Name

"Alarm Group 1"

< > ACCEPT <-CNCL

(M - 8.1.3) Upper limit

If the measured value is above this limit for more than the duration of Upper delay time, it will cause an alarm condition.

8.1.3 Upper limit

-15.0 °C

< > ACCEPT <-CNCL

(M - 8.1.4) Lower limit

If the measured value is below this limit for more than the duration of lower delay time, it will cause an alarm condition

8.1.4 Lower limit

-20.0 °C

< > ACCEPT <-CNCL

(M - 8.1.5) Initial Delay time

This is the time that has to pass before a compartment will be actively monitored for an alarm situation. This delay will only be used when a compartment and alarm group are linked.

(This is intended to ignore alarms at startup, e.g. in case the refrigerator has started and the compartments have not yet reached their set point temperature).

(M - 8.1.6) Upper delay time

This is the time that an upper alarm condition has to be 'true', before an alarm will be evoked.

(M - 8.1.7) Lower delay time

This is the time that a lower alarm condition has to be 'true', before an alarm will be evoked.

(M - 8.2) Alarm Group 2

(Menu structure as menu 8.1)

(M - 8.3) Alarm Group 3

(Menu structure as menu 8.1)

(M - 8.4) Alarm Group 4

(Menu structure as menu 8.1)

(M - 8.5) Alarm repetition

Define how many times an alarm is repeated.

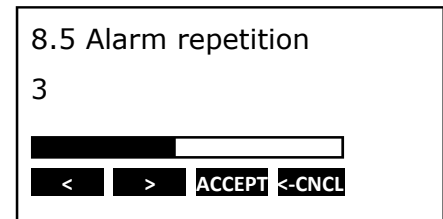

(M - 8.6) Alarm repetition interval

Define the interval between alarms that are repeated

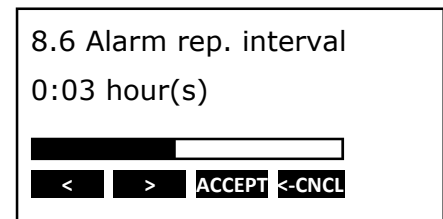

(M - 8.7) Output function

Define the function of the alarm output (AO) on CON1: alarm output or remote on/off.

By choosing "remote on/off", the output can be used for activating a refrigerator.

The option "Alarm output" is used to activate an external device (sound or light) in case of an Alarm (See Menu 2.9)

(Menu - 9) Printer settings

This menu enables you to configure the printer functions as desired:

(M - 9.1) Graph upper limit

Upper limit for the graphical printout

(M - 9.2) Graph lower limit

Lower limit for the graphical printout



Note: If the total temperature range between upper and lower limit can be divided by 9 you achieve an optimal result for the printout.

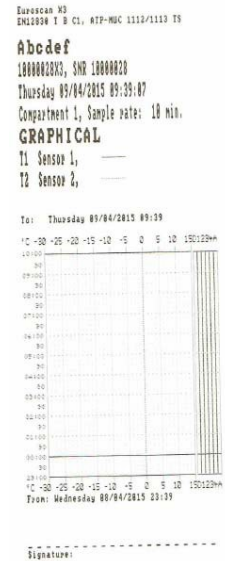

(M - 9.3) Graph mm per hour

A graphical printout consumes a lot of paper. This parameter enables you to set the scaling of the printout (mm of paper per hour). Set a value to avoid wasting paper and work on a greener environment

(M - 9.5) Delivery ticket setting

Set the way the delivery ticket presents its data.

Print [Actual only], [Actual + average] or [Actual + average + min/max] temperature.

(M - 9.6) Events ticket setting

Set the way the event ticket presents its data. Print [Print all] or [Print no coordinates]

(M - 9.7) Print time period

Set time period (explained in Menu 1.7 description)

(M - 9.8) Day start time

Set day start time for printing (explained in Menu 1.8 description)

(M - 9.9) Day end time

Set day end time (explained in Menu 1.8 description)

(Menu - 10) General settings

This menu lets you set the general settings of the X3 unit.

(M - 10.1) Temperature unit

Here you can choose if your temperature is presented in Celsius or Fahrenheit.

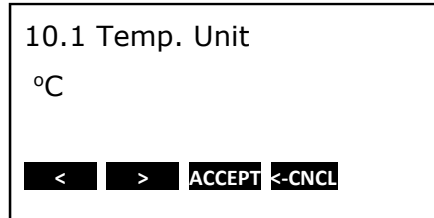

10.1 Temp. Unit
°C
[<] [>] [ACCEPT] [←-CNCL]

(M - 10.2) Distance unit

Here you can choose if you distance is presented in kilometer or miles

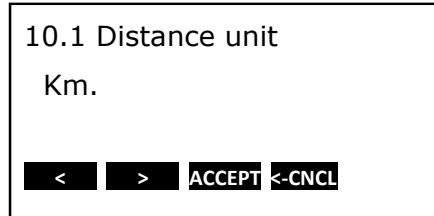

10.1 Distance unit
Km.
[<] [>] [ACCEPT] [←-CNCL]

(M - 10.3) Date format

Here you can choose in what format your Date is presented (mm/dd/yyyy or dd/mm/yyyy)

(M - 10.4) Sample rate

This is the interval time in minutes for storing a temperature measurement.

(M - 10.5) Vehicle ID

16 characters are available for assigning vehicle identification or name. It is necessary to enter a unique way to identify your vehicle, like for example: registration number or chassis number in the case of a trailer. The vehicle ID will be shown on every printout, and can be found in the header together with the serial number and header text.

(M - 10.6) Header text

16 characters are available for assigning a header title (usually the company name). The header text will be shown on every printout.

(M - 10.7) Customer ID

This field is used on the website, for automatic customer account association. If you do not have a number please leave this field empty.

(M - 10.8) Pin number

In this menu you have the capability to change the pin code that is set for the recorder. The pin code is intended to prevent unauthorized people access to the parameter menu.

Please note: Do not forget to write down the new pin code and store it in a safe place. There is no master code available to get access to the parameter menu in another way.

(Menu - 11) Communication settings

Here you can change the protocols that will be used for communication with the internal or external connected devices.

(M - 11.1) COM 1 port settings

(External COM 1 of COM2 on the backside of the X3)

The following options are available:

Euroscan protocol		
	No protocol	Disables communication
	UCP protocol	For communication between all Euroscan devices
*	Bluetooth protocol	For communication via an Euroscan BT module
Mapping protocols		
**	External	Mapping data from PF6 devices
	DC500	Mapping data from DC500/X1 devices
	Transcan	Mapping data from Transcan units
Security Lock systems		
	ELIM	ELIM Door lock system
	Transafety	Transafety Door lock system
System specific		
	Inventure EBS	EBS system
	Z-logger	Customer specific
3 rd Party integration		
	Partner Protocol	Standard Euroscan integration protocol
	old ES protocol	Backwards compatible integration protocol

(M - 11.1.2) * BT Settings

This menu is for optional products only. Please contact your customer care team

This protocol is not useable on COM5. The BT on COM5 is only for usage with EuroTool7

Bluetooth PIN (11.1.2.1)

This is a 16 digit numerical PIN code for identification at the Bluetooth base station.

BT base (11.1.2.2 -- 11.1.2.9)

This is the hexadecimal address of the Bluetooth base station [xx : xx : xx : xx : xx : xx]

(M - 11.1.3) ** External sensor settings

External sensor mode

This mode is needed for mapping sensors from Euroscan platform 6 devices Here you can setup if this port will be receiving or transmitting

Receive/Transmit mode

Polling

At the selected Poll interval, data from the remote sensor(s) is requested.

Non polling

The remote sensor transmits data to the recorder on its own intervals.

Poll interval

Is the frequency at which the data of external sensor devices is requested.

(M - 11.2) COM 2

(external COM 2 on CON2) similar to **COM1**

(M - 11.3) COM 3

Reserved for future applications

(M - 11.4) COM 4

Internal COM port used to communicate with the onboard modem. When changing the settings of this com-port, your unit might not be able to come online anymore.

Maintenance

Inspection

Perform visual inspection of the recorder. Especially look for cracks of housing, rust, oxidation, cured rubbers, cut or broken cables.

Error codes

If the display shows one of the following values:

OC	(I)	the input is activated but no sensor is connected
	(II)	the sensor has an open circuit (sensor or wire failure)
SC	(I)	the sensor has a short circuit (sensor or cable failure)
---	(I)	the sensor is N/A (Not Available)

RMA

In case material needs to be returned to Euroscan, please follow RMA instructions below to secure proper handling and support. Return Material Authorization should be obtained by contacting your customer care team.

Please have the following information at hand:

- Product type
- Product serial number

Before returning goods please make sure the RMA number is clearly visible on the outside of the package and included in any guiding documentation. All RMA's require:

- Ship-to address
- Bill-to address
- Contact name
- Phone number
- E-mail address
- Method of return shipment
- Your P.O. number
- Detailed description of the problem
- Any special instructions

If the unit cannot be repaired, you will receive a letter of explanation, and be given the option to have the unit returned to you at your expense or to have us scrap the unit.

Replace paper roll

A colored line appears on the last meter of paper and indicates that the paper roll needs to be replaced soon. To change a paper roll please proceed as follows:



1.) Pull Down clear plastic flap.



2.) Printer slides forward and can be pulled out. Now you can remove the empty roll.



3.) Put new paper roll into the printer and make sure that the paper is fed in the correct way.



4.) After changing the paper please install the printer with the flap open.



5.) Close the flap only after the printer is fully inserted.



6.) Test if the paper roll is properly replaced by printing any ticket.



Please tear paper only when printing has stopped to avoid damage to the printer mechanism!



A printout must be torn downwards over the edge of the bottom plastic part.

Euroscan TX3 / RX3 recorder calibration

The Euroscan TX3 / RX3 recorders have an option to adjust the offset of the A/D converter with a correction factor. Because this offset is subject to aging, it is recommended to repeat this procedure on a regular basis (i.e. at the annual reference check).

The correction factor is a fixed parameter used in the formula which converts the measured resistance into the corresponding temperature. This procedure is NOT applicable for calibrating individual sensors. Note that the effect on the measured and displayed temperature is not linear.



Adjusting the correction factor applies to ALL temperature sensors.

Set the correction factor

- 1 Connect the temperature calibration block to CON4 of the recorder
- 2 Enter the parameter menu by pressing the <green button> for 4 seconds.
- 3 The display will show: "ENTER PINCODE". Enter the factory PIN code.
- 4 Select menu [12 Factory settings] by using the <blue button> and <yellow button>. Enter the menu by pressing the <green button>
- 5 Select menu [12.5 Correct. Factor] by using the <blue button> and <yellow button>. Enter the menu by pressing the <green button>
- 6 The recorder will now compare the measured value of the resistor with the 'expected' value of the calibration block. On the first line, the recorder will display a recommended correction factor based on the measured value. This factor can be set on line two.
- 7 Use the <blue button> and <yellow button> to adjust the correction factor. The correction factor is limited from -9 to +9.
- 8 The correction factor will be applied after pressing the <green button>.



EC-2200-00

Euroscan TX3 / RX3 recorder temperature verification

Introduction

This procedure applies to all Euroscan temperature recorders. The verification procedure determines the accuracy of the installed Euroscan recorder, together with the attached sensors. The combined measuring system must be tested, at least every 12 months, to ensure that it functions within the given tolerances of ($\pm 1^{\circ}\text{C}$). The verification procedure described here is a mere testing procedure, and is based on the assumption that the configuration parameters of the recorder are set correctly. There are no further setting options on the recorder or the sensors. If the result of the verification is not within the given tolerance, replace the sensor and re-test. If the reading is still outside the ($\pm 1^{\circ}\text{C}$) tolerance, please contact your customer care team for returning the recorder.

Equipment

- A reference thermometer with a valid calibration certificate, conforming to National and European Standards, and must have an indicated tolerance of ($\pm 0.2^{\circ}\text{C}$) of the given temperature.
- Cable tie
- Verification certificate
- A bowl containing crushed ice and demi water (only for freezing point test).

Procedure

The verification procedure should be performed within $\pm 5^{\circ}\text{C}$ of the operating temperature of the vehicle/trailer. For chilled transport, the ideal verification temperature is 0°C .

Two different verification methods for temperatures exist: the first one is performed at 0°C (freezing point test) and the second one at all other temperatures.

In both cases, each individual sensor is tested. The results are documented on the verification certificate, together with the serial number of each sensor. In order to successfully conduct this test, the recorder should be changed to single display for the selected sensor.

In order to perform the test in a meaningful way, the sensor of the reference thermometer has to be connected with the vehicle sensor in a thermo-conductive way. This can be achieved by directly binding them together using a cable tie.

Freezing Point Test

When conducting the freezing point test (0°C), the sensors are individually placed into a mixture of crushed ice and demi water.

The sensors are immersed at least 10 cm into the crushed ice and demi water mixture, which should be stirred every 30 seconds, in order to provide an equal temperature distribution.

When the temperatures have stabilized for at least 5 minutes, the values given by the recorder and the reference thermometer are filled onto the form, together with the serial numbers of the sensors.

Other temperatures

If a temperature verification other than 0°C is necessary, the test should be performed at a temperature of $\pm 5^{\circ}\text{C}$ of the future operation temperature. Therefore, in case of vehicles transporting frozen products, the test should be undertaken at -20°C . The vehicle compartment should be cooled to the required temperature, and the cable to the reference thermometer, fed underneath the closed doors, with the instrument outside.

When the temperatures have stabilized for at least 5 minutes, the values given by the recorder and the reference thermometer are filled onto the form, together with the serial numbers of the sensors.

Evaluation

If one of the sensors does not pass the test, the sensor should be replaced and perform the test again. If the result is still negative the temperature recorder from Euroscan should be returned in according to the described RMA procedure.

Technical specifications

For technical support please contact your customer care team:

1 Technical specification:

- Operating voltage: 10-32VDC (negative earth), protected against alternator load shedding
- Power consumption: nominal value 0.6W, max. 25W (while printing)
- Temperature in operation: -30 °C / +70 °C (-22 °F / 158 °F)
- Temperature maximum: -40 °C / +85 °C (-40 °F / 185 °F);
- Humidity: 97% relative humidity at 25 °C (77 °F).
- Memory size: 8MB
- inputs
 - o 6x temperatures for Euroscan sensors: measuring range -50°C to +70°C
 - o 1 x digital for display background light, active >5VDC
 - o 4 x digital, closed circuit
- Outputs
 - o 1 x open input, switched to ground and current limited to 1A
- Data ports
 - o 2x RS-232 connectors for external devices
 - o 1x CAN bus connector
 - o 1x Internal Bluetooth module
- Accelerometer

2 Appliance class:

This product is categorized in appliance class III

3 Ventilation:

No special requirements. Euroscan recorders are designed for use in an automotive environment.

4 IP rating

Euroscan TX3, trailer version for outside mounting, IP65

Euroscan RX3, cabin version for cabin mounting, IP20

5 Dimensions (W x H x D):

Euroscan TX3, 225 x 185 x 111.77mm (8.86 x 7.28 x 4.4 inch)

Euroscan RX3, 186 x 58 x 150 (7.32 x 2.28 x 5.91 inch)

6 Maintenance

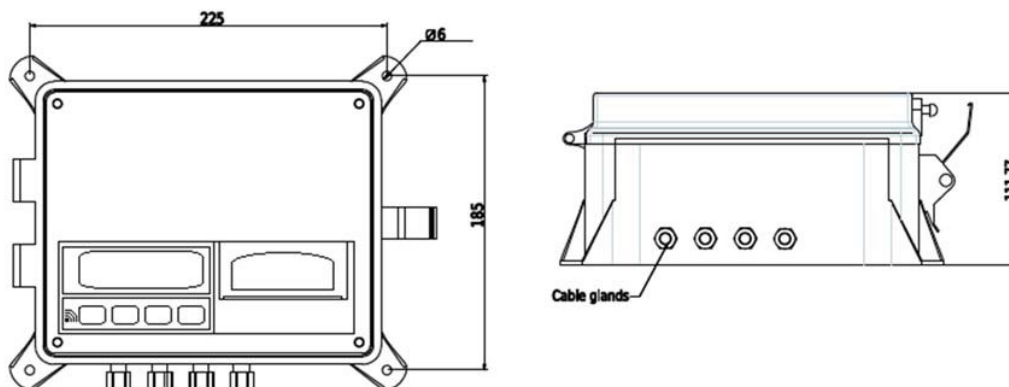



Use for cleaning a moistened duster, without alcohol or other volatile cleaning products.

7 Battery

Unit contains a lithium battery. After replacing the battery, dispose the empty battery according to all applicable national laws and regulations.

Factory settings

Temperature inputs

T1 input	On
T1 type	Temperature
Logging	Avg.
Alarm	Avg.
T2 input	On
T2 type	Temperature
Logging	Avg.
Alarm	Avg.
T3 input	Off
T4 input	Off

Digital inputs

D1 input	Off
D2 input	Off
D3 input	Off
D4 input	Off

Compartment settings

compartment 1	On
compartment name	compartment 1
Print T1	Yes
Alarm on T1	Yes
Print T2	Yes
Alarm on T2	Yes
Print T3	No
Alarm on T3	No
Print T4	No
Alarm on T4	No
Print D1	No
Print D2	No
Print D3	No
Print D4	No
compartment 2	Off
compartment 3	Off
compartment 4	Off

Alarm settings

alarm group 1	Off
alarm group 2	Off
alarm group 3	Off
alarm group 4	Off
Alarm repetitions	0 repetitions
Alarm behind PIN	No

Printer settings

Graph upper limit	+ 15 °C
Graph lower limit	-30°C
Graph mm. per hour	5 mm
User menu	Yes
Delivery ticket setting	Actual only
Event ticket setting	Print all
Print time period	10 hours
Day start time	00:00
Day end time	18:00

General settings

Distance unit	Km.
Temp. unit	°C
Date format	dd/mm/yyyy
Sample rate	10 min.
Header text	Abcdef
Pin code	1111

Communication settings

COM1 function	UCP protocol
COM2 function	UCP protocol
COM3 function	No protocol
COM4 function	UCP protocol
CAN0 function	No protocol